

TAKSTAR® 得胜

EKX-808 | 8X8数字矩阵处理器 8X8 DSP DIGITAL MATRIX PROCESSOR



使用说明书
User's Manual

EKX-808数字矩阵处理器

目录

产品功能	1
前面板说明	1
后背板说明	2
Pc软件	2-3
Pc软件说明	4-10
技术指标	11
配件清单	11
背板控制端口示意图	12-14
232通信协议控制代码	15-22
使用安全事项	24
英文说明	25-47

EKX-808数字矩阵处理器

产品功能

- 32位DSP芯片处理，96kHz采样率，24bitAD/D A转换。
- 带有+48V幻象电源，话筒和线性输入增益切换，其中话筒的输入灵敏度可调。
- 输入处理部分包含高切，低切，自动增益，参量均衡，独立反馈抑制，噪声门，增益，静音，相位，联动调节，音量编组调节等处理功能。
- 输出处理部分包含分频，参量均衡，增益，静音，压缩/限幅器，相位，延时，联动调节，音量编组调节等处理单元。
- 所有通道的PEQ增益、带宽、频率连续可调，类型可选择: 参量均衡、低架滤波、高架滤波、低切滤波、高架滤波、移相1阶、移相2阶。
- 所有输入输出之间可以自由进行矩阵式分配，且每个输入输出通道名称可以更改。
- 所有输入输出通道带独立的相位曲线调整功能，在PEQ类型选择移相1阶是180度曲线调整，移相2阶是360度曲线调整。
- 所有高切、低切滤波器，分频器的类型可选择：巴特沃斯、林奎瑞利、贝塞尔，斜率可选。
- 输入通道噪声门的门限值、启动时间、恢复时间连续可调。输出通道的压缩/限幅器的阈值、比率、启动时间、恢复时间连续可调。
- 所有输出通道的延时模块都具有高达680mS的延时时间。
- 任意通道之间参数设置可以自由复制，以及任意通道可以进行联动调节。
- 可在任意一个输入或输出通道时看到当前所有的输入或输出通道的PEQ曲线调整图。
- 独特的AUX专用通道设计，可混编全部话筒通道，具有专业的ECHO及REV双引擎多重效果器，即可美化修饰音色，也可全面支持卡拉OK功能，可广泛应用于会议、多功能厅等各种应用场合。
- AUX通道具有强大的自动混音处理功能，权重、增益、衰减比例等参数连续可调。同时具有自动摄像跟踪触发功能，触发阈值、幅度、启动时间、恢复时间等参数连续可调，AEC自动回声消除及系统环境噪声消除功能，其有效降低在远程会议环境中由于话筒的二次拾音产生的声学回声问题，同时还可以有效消除现场的空调、风扇等固有的环境噪声。以及独立的PEQ、压缩器、音量等调节功能。
- 内置测试信号发生器，输出方式可选粉红噪声，白噪声及20Hz - 20kHz正弦波可调，信号幅度可调。
- 面板带USB控制端口，背板有232&485控制端口，及以太网连接远程控制端口，一键式连机使用户操作更简易、快捷。
- 21个用户预设，整机状态和每个预设都可以单独存储和调用。ID设置功能可以级联控制255台机器，还具有密码保护功能，使设备更安全。

前面板说明

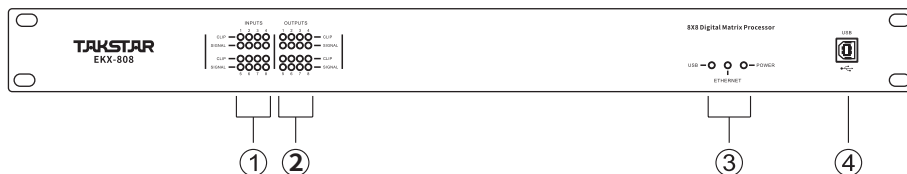

① 输入通道电平指示灯

2段高精度LED电平指示灯,显示当前输入通道的电平状态。

② 输出通道电平指示灯

2段高精度LED电平指示灯,显示当前输出通道的电平状态。

③ 指示灯

USB连接信号灯，网络连接信号灯，以及电源指示灯。

④ USB接口

用来与PC和中控设备连接，进行实时控制。

EKX-808数字矩阵处理器

后背板说明

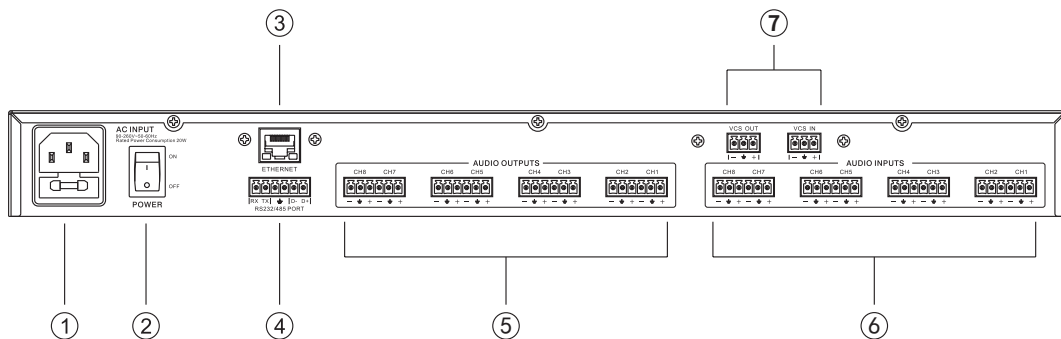

- ① 电源插座
AC~95-264V 50-60Hz。
- ② 电源开关
- ③ 以太网连接控制端口
可通过设定IP地址来使用网线或路由器（接WIFI）进行连接控制，也可接入INTERNET网络进行异地远程控制。
- ④ RS232/485端口
通过RS232端口实现中控设备的远程实时控制,也可用USB转换线来连机控制,还可以通过485来进行级连控制。
- ⑤ 信号输出端口1-8
- ⑥ 信号输入端口1-8
- ⑦ AEC远入远出端口
VCS IN为远端传输过来的信号输入口，VCS OUT为输送到远端去的信号接口。

PC软件

提示：所需PC控制软件和产品说明书都保存在附件的光盘。

USB数据线连机步骤：

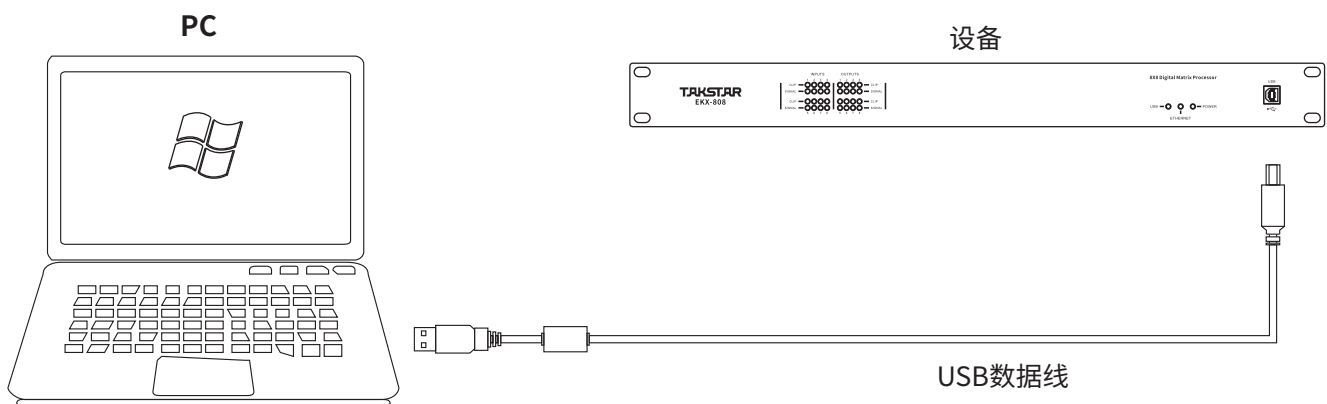

USB数据线连接方式

EKX-808数字矩阵处理器

一. 点击安装光盘上随机附送的PC控制软件，根据默认提示按“下一步”进行操作，直到软件安装成功后按“完成”退出，出现以下窗口后关闭此控制软件窗口：

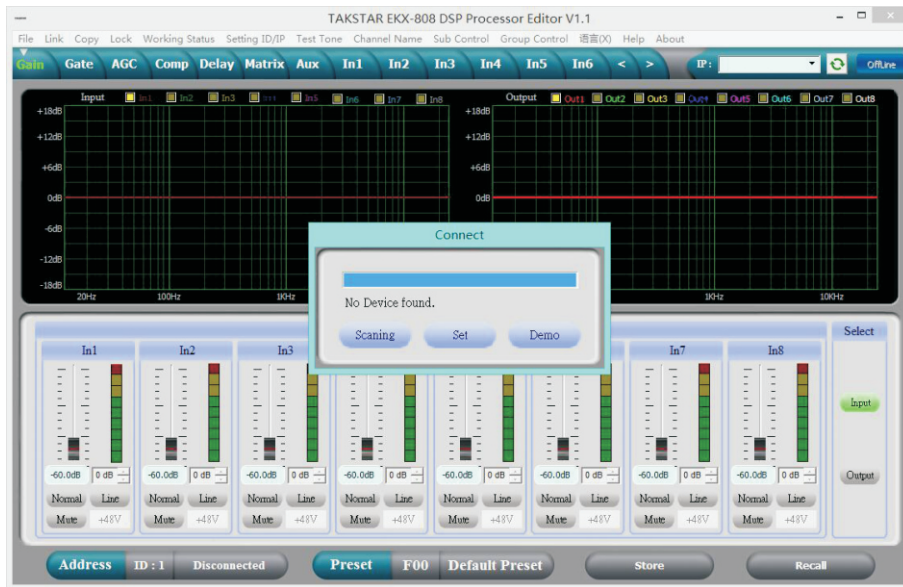

二. 将电脑和处理器用USB数据线连接起来，打开处理器电源，此时电脑会自动找到新硬件并且提示硬件已安装而且可以使用。

三. 打开PC控制软件，PC软件会自动寻找USB并且连机，联机后右上角联机按键会变成绿色，并且显示“Online”，说明软件与机器已联机成功，此时可以通过控制软件对处理器进行操作。退出时同样先点击“Online”按键，再关闭软件界面窗口即可：



EKX-808数字矩阵处理器

PC软件说明

一.音量控制界面



1.菜单栏

文件	打开和保存预设参数，以及整机数据上传到电脑和整机数据下载到机器
链接	输入输出通道可以任意组合，来联动调节所有参数
复制	输入和输出通道的所有参数可以任意进行复制
机器锁	用来设置面板锁密码，以确保机器的安全使用
工作状态	可设置机器的工作状态；不记忆，即时记忆（需要在U01-21模式下），不记忆且开机默认U01。
ID与网口IP设置	可设置不同的ID来进行多达254台机器的级联控制，以及通过设置ID和IP地址来进行远距离网络控制和无线WIFI控制。
测试信号	自带信号发生器，可输出粉红噪声，白噪声以及正弦波信号20Hz-20kHz
通道名称	可编辑所有通道的名称，以便于用户好管理
编组音量	可对输入和输出的任意通道音量进行编组，进行同步控制
群组音量	独立输入和输出4个群组控制，可通过墙面板来控制不同区域
语言	中英文菜单可以切换

2.频谱区：可以任意勾选显示输入输出通道的PEQ曲线和相位曲线图。

3.音量控制区：可以调整所有输入输出通道的增益参数，以及每个通道的相位和静音参数。

4.预设操作区：用来保存和调用预设参数，以及显示当前预设参数的状态。

EKX-808数字矩阵处理器

二.噪声门界面

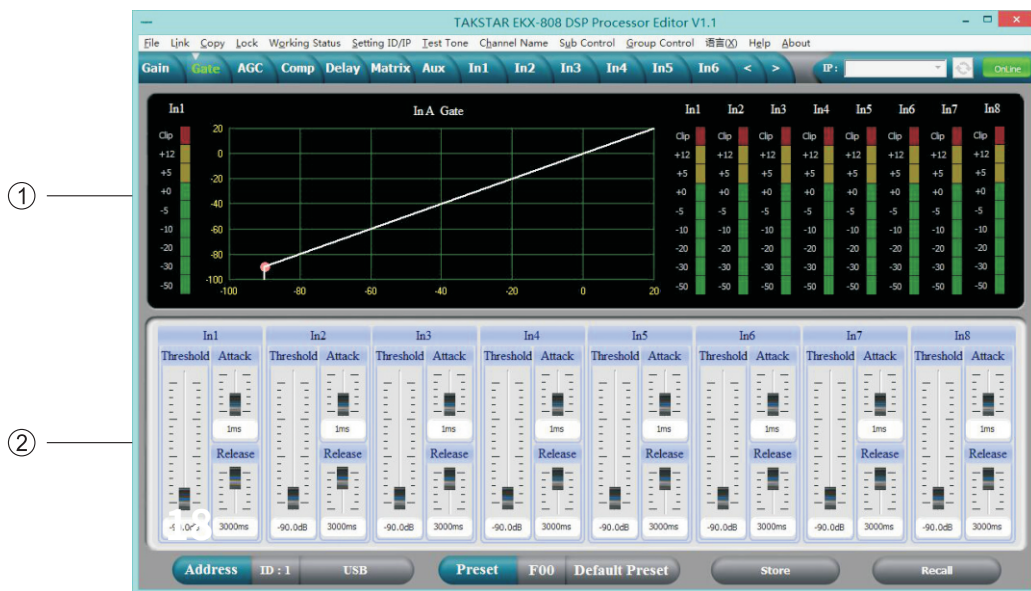

- 1.显示噪声门的阈值曲线图，以及所有通道的电平指示灯。
- 2.可设置所有输入通道的噪声门参数：阈值-90dB到+20dB，启动时间1-999ms，恢复时间1-3000ms可调。

三.自动增益控制界面

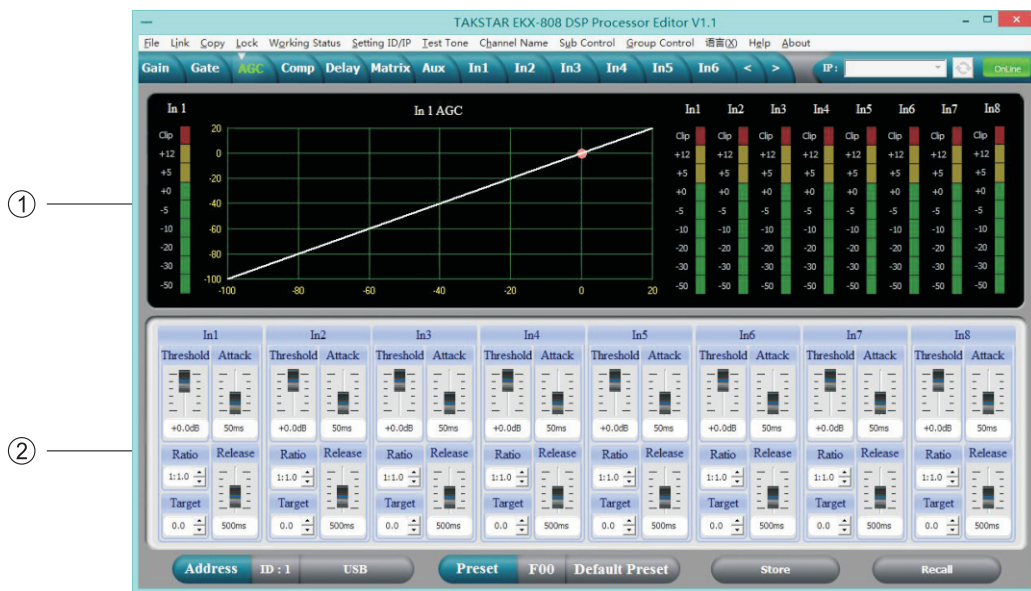

- 1.显示自动增益变化的曲线图，以及所有通道的电平指示灯。
- 2.可设置所有输入通道的AGC控制参数：阈值-60dB到0dB，目标电平-60dB到0dB，启动时间1-999ms,恢复时间10-3000ms，比列1:1.0-1:20-LIMIT连续可调。

EKX-808数字矩阵处理器

四.压缩器界面

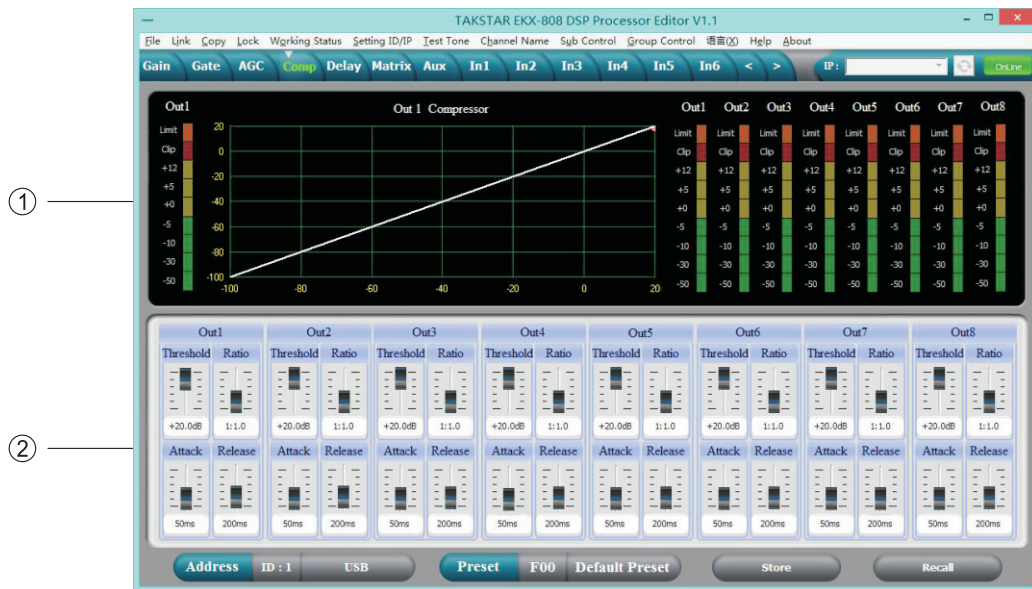

1.显示压缩状态曲线图，以及所有通道的电平指示灯和压缩状态灯。

2.可设置所有输出通道的压缩器参数：压缩值-60dB到+20dB，压缩比率1:1、1: 10、LIMIT，启动时间1-999ms，恢复时间1-3000ms可调。

五.延时界面

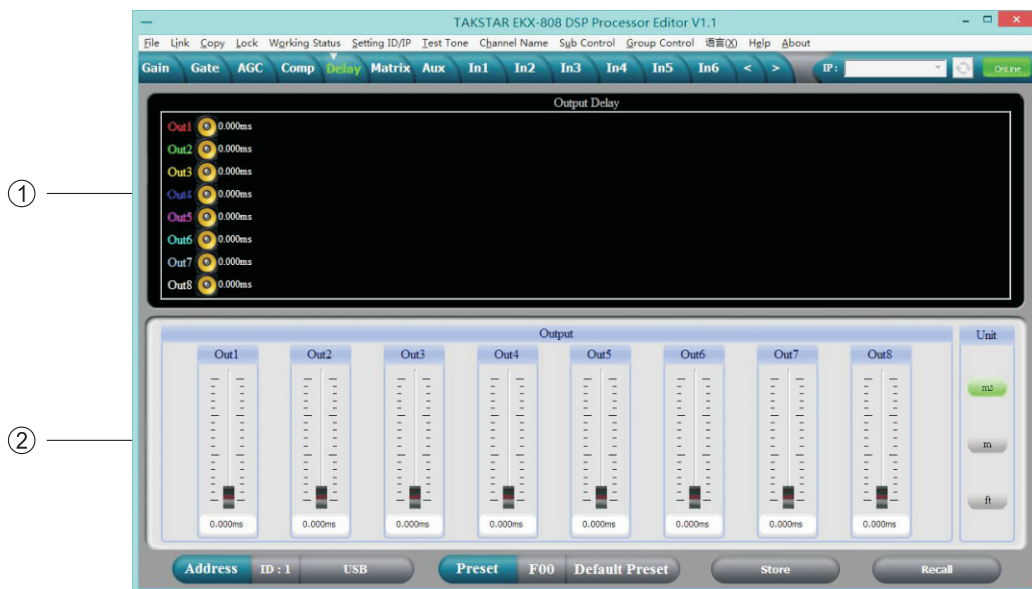

1.直观的显示所有通道的延时参数状况图。

2.可以调整所有通道的延时参数，调整范围是0-680ms，分别有毫秒、米、英寸单位切换显示。

EKX-808数字矩阵处理器

六.矩阵界面



- 1.直观显示整机的电气连接图，通过点击方块可进入相应通道编辑功能界面，而且每个通道的名称也可以编辑。
- 2.所有输出通道可以选择输入通道信号源的任意路由搭配。

EKX-808数字矩阵处理器

七.辅助通道界面

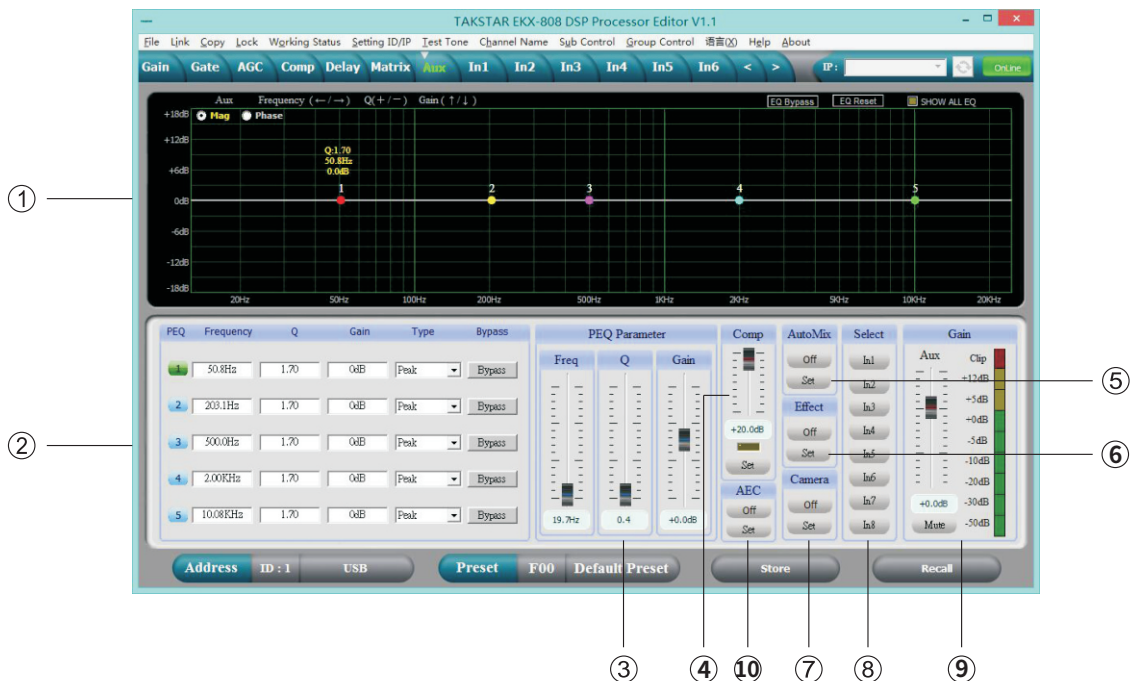

- 1.选择Mag界面可以调整辅助通道的参量均衡和高低切参数，选择Phase界面可以调整辅助通道的相位曲线。
- 2.所有参量均衡的增益、Q值、频率、类型可以调整，以及旁路按键选择。PEQ类型选择有：均衡;低架;高架;低切;高切;相位180度;相位360度调整。
- 3.参量均衡的增益、Q值、频率可以用推杆来进行调整，也可以用键盘的上下左右箭头来控制。
- 4.辅助通道的压缩值调整推杆，点击Set按键后进入辅助通道的压缩器参数设置界面：压缩值-90dB到+20dB可调，压缩比率1:1、1: 10、LIMIT，启动时间0-200ms，恢复时间0-999ms可调，还有压缩指示灯显示。
- 5.自动混音的ON/OFF开关，点击Set键进入自动混音的参数设置界面：每路输入都配有自动混音的开关，并且话筒的优先权增益可以独立设定，对应每路的电平显示。总音量可以独立去控制。自动混音为增益共享型，衰减的比率深度也可以单独设定。
- 6.辅助通道的效果ON/OFF开关，点击Set进入效果参数设置界面：回声有音量、重复、延时、预延时参数可调，混响有音量、反射、时间、预延时参数可调，还有一个总效果音量调整推杆。
- 7.摄像跟踪的ON/OFF开关，点击Set按键进入摄像跟踪参数设定窗口：首先要选择摄像跟踪的对应通道（注意只有被选择进入辅助通道的输入通道才可以进入摄像跟踪通道），然后选择合适的阈值（-50-0dB）、启动时间(0-5000ms)、恢复时间(0-5000ms)参数，当其中任何一个通道信号超过阈值的时候，这个通道会被自动打开且进行摄像跟踪，而且会按照输入A到输入H的优先顺序进行。
- 8.输入选择功能，可以选择要混入辅助通道的输入1-8通道。
- 9.辅助通道的增益控制推杆，以及静音键和电平指示灯。
- 10.回声消除的ON/OFF开关，点击Set键进入回声消除的音量控制和降噪功能界面，回声消除的话筒输入音量，远入和远出音量独立可调。注意，在使用的时候本地话筒音量和远入信号音量相当，这样效果会最佳，不同环境下可适当微调VCS IN和AEC OUT的音量来达到最佳处理效果。NR降噪功能6-15dB可选，注意开了NR之后会有一定的延时。

EKX-808数字矩阵处理器

八.输入界面



- 1.可以调整输入通道的参量均衡和高低切曲线，以及当前通道的相位曲线。而且可以勾选同步显示非当前通道的参量均衡曲线和相位曲线。
- 2.所有参量均衡的增益、Q值、频率、类型可以调整，以及旁路按键选择。PEQ类型选择有：均衡；低架；高架；低切；高切；相位180度；相位360度调整。
- 3.参量均衡的增益、Q值、频率可以用推杆来进行调整，也可以用键盘的上下左右箭头来控制。
- 4.低切的频率20HZ-20KHZ可调整，斜率可以选择“Butterworth”巴特沃斯，“Bessel”贝塞尔，范围是-6dB到-48dB可调。
- 5.高切的频率20HZ-20KHZ可调整，斜率可以选择“Butterworth”巴特沃斯，“Bessel”贝塞尔，范围是-6dB到-48dB可调。
- 6.输入可选择反馈抑制的级别，一共有四个档位选择（LEVEL1-4）
- 7.输入通道增益、静音、相位可以独立控制，以及通道的电平显示灯。

EKX-808数字矩阵处理器

九.输出界面



1. 可以调整输出通道的参量均衡和高低切曲线，以及当前通道的相位曲线。而且可以勾选同步显示非当前通道的参量均衡曲线和相位曲线。
2. 所有参量均衡的增益、Q值、频率、类型可以调整，以及旁路按键选择。PEQ类型选择有：均衡；低架；高架；低切；高切；相位180度；相位360度调整。
3. 参量均衡的增益、Q值、频率可以用推杆来进行调整，也可以用键盘的上下左右箭头来控制
4. 低切的频率20HZ-20KHZ可调整，斜率可以选择“Butterworth” 巴特沃斯，“Bessel” 贝塞尔，“Linkwitz-Riley” 宁可锐，范围是-6dB到-48dB可调
5. 高切的频率20HZ-20KHZ可调整，斜率可以选择“Butterworth” 巴特沃斯，“Bessel” 贝塞尔，“Linkwitz-Riley” 宁可锐，范围是-6dB到-48dB可调
6. 输出通道增益、静音、相位可以独立控制，以及通道的电平显示灯

EKX-808数字矩阵处理器

技术指标

系统规格	频率响应	20Hz-20kHz,-0.3dB
	动态范围	115dBu
	失真度	<0.005% at 1kHz (0dBu)
	串音	>70dBu, 20Hz-20kHz
	共模拟制比	>75dBu 1KHz
话筒输入	类型	平衡式连接
	幻象电源	+48V DC
	增益	50dBu
	阻抗	2k ohm
音乐输入	类型	平衡式连接
	增益	35dBu
	输入最大电平	+18dBu
	阻抗	>10k ohm
输出部分	类型	平衡式连接
	最大输出电平	+18dBu
	阻抗	<500 Ω
数字处理部分	24bit sigma-delta A/D、D/A转换	
	32 bit DSP, 96kHz采样率	
电源	AC 95V-264V 50/60Hz	
尺寸(长*宽*高)	482*254*44MM	
重量	2.7KG	

配件清单

1. 光盘 (含PC控制软件和用户手册)
2. USB连接线一条
3. 电源线一条

EKX-808数字矩阵处理器

背板控制端口连接示意图

1.以太网连接端口：可以通过网线直接与电脑连接进行控制；也可以通过交换机连接多台机器进行控制，但需要将每台机器的IP地址和ID码设置的不同；或者可以连接路由器进行无线WIFI控制，但也需要将每台机器的IP地址和ID码设置不一样，否则会造成地址冲突连接不上。

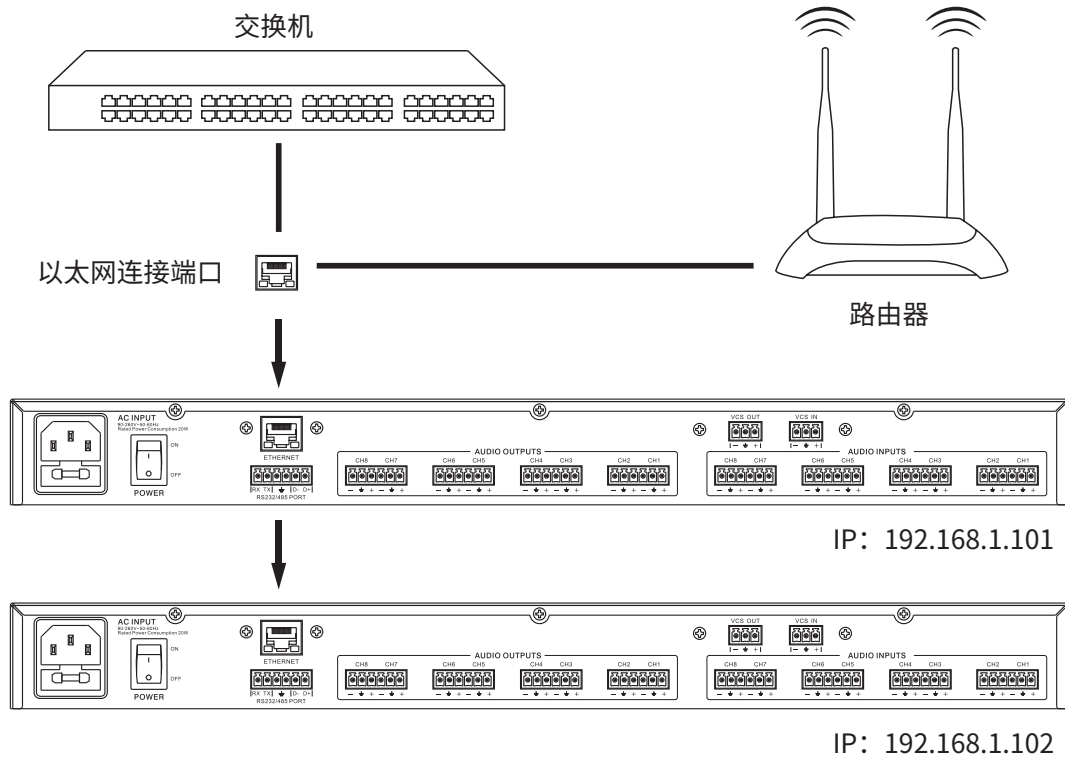

2.RS232连接端口:可以通过232端口进行中央控制,也可以用来与PC连机控制.

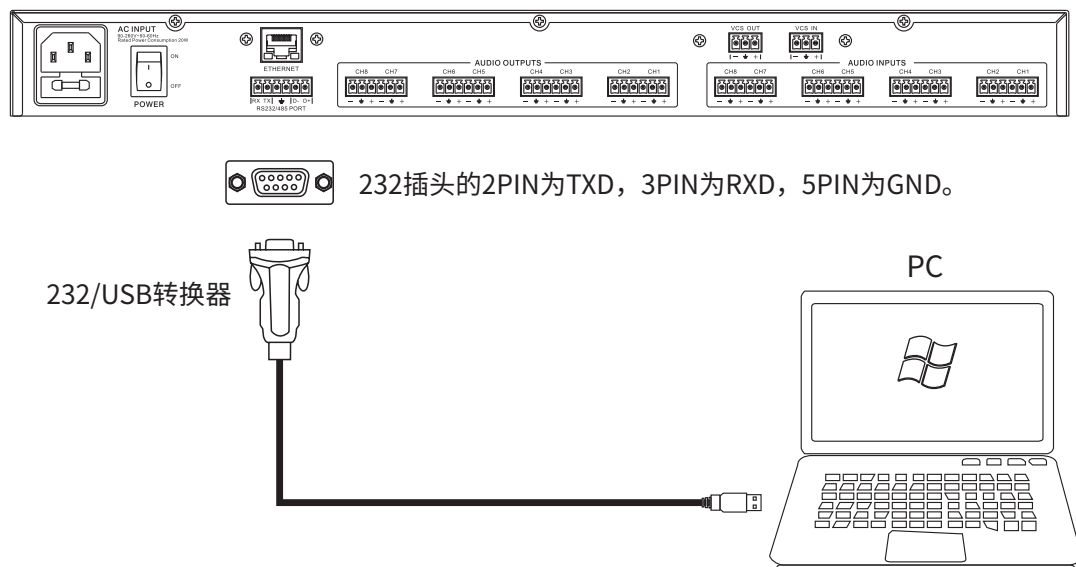

EKX-808数字矩阵处理器

3.RS485级连机控制端口：可以通过485线把多台机器串联在一起，然后选择不同ID来进行控制。

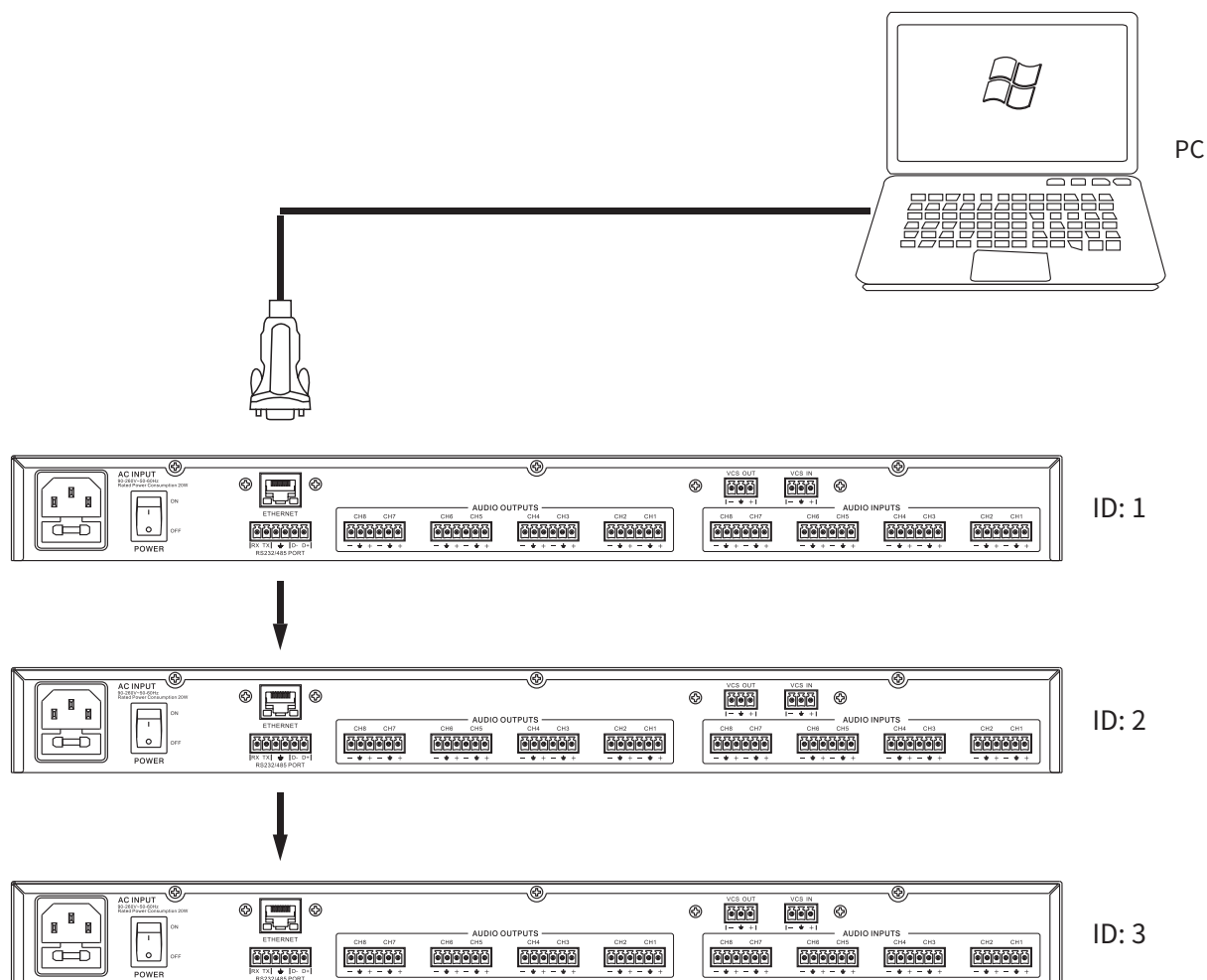

EKX-808数字矩阵处理器

4.AEC回声消除功能操作说明

AC回声消除系统连接图

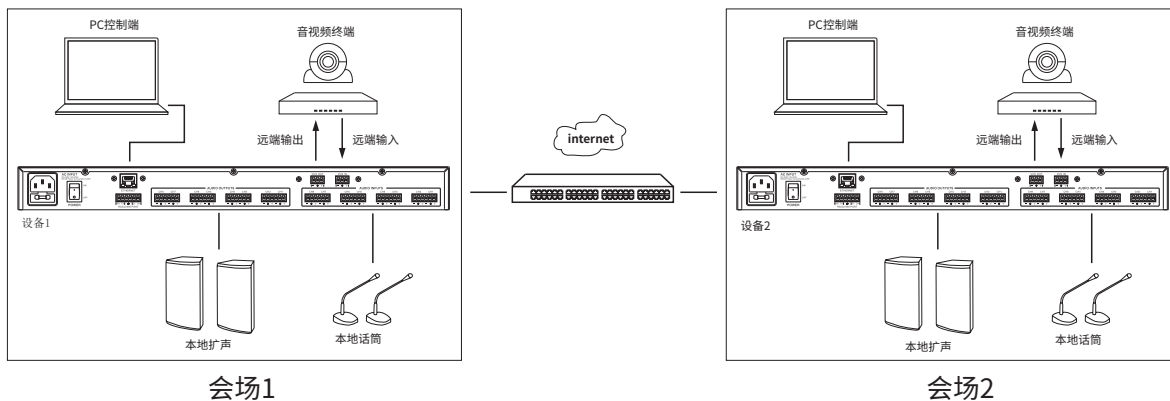

a).首先打开输入通道话筒的增益和幻象电源。



b).然后在Matrix界面选择AUX通道路由到输出通道，因为AEC功能是在AUX通道，所以AEC可任意路由到输出通道（注意不要把输入通道不经过AUX直通到输出通道去）。



c).最后进入AUX界面，首先选择要混入AUX通道的输入话筒通道，然后打开AEC的ON开关，点击set按钮之后可以进入AEC回声消除的音量控制界面，正常情况下不用调就可以对回声进行消除，如果回声消除效果不理想，可以微调VCS IN和AEC OUT的音量来匹配电平（注意MIC IN的电平也要跟远入音量VCS IN的相当）。NR是降噪功能，如果有背景噪声（如风扇，空调等）可以打开使用，但是注意NR降噪有一定的延时在里面，而且本地输出的音色也就和远端输出一样了。

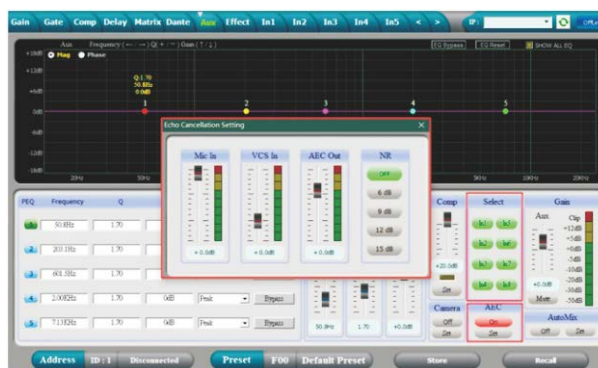

EKX-808数字矩阵处理器

232通信协议控制代码

1. 控制程序包格式

	0	1	2	3	4	5	6	7	8
	DLE	STX	Device Address	CMD	Data1	Data2	Date3	STX	DLE
Packet	0x7B	0x7D	1~254	0x40~0x5C	0x??	0x??	0x??	0x7D	0x7B

2, 指令细节

(1) 调用预设矩阵(0x40)

	0	1	2	3	4	5	6	7	8
	DLE	STX	Device Address	CMD	Factory/User	Preset	0x00	STX	DLE
Packet	0x7B	0x7D	1~254	0x40	F: 0, U: 1	0~12	0	0x7D	0x7B

范例 (调用用户预设U02矩阵) : 7B7D01400101007D7B

(2) 增益控制(0x41)

	0	1	2	3	4	5	6	7	8
	DLE	STX	Device Address	CMD	In/Out	Channel	+/-	STX	DLE
Packet	0x7B	0x7D	1~254	0x41	In:0 Out:1	00~15	+: 0, -:1	0x7D	0x7B

范例 (提升In1增益) : 7B7D01410000007D7B

(3) 静音控制(0x42)

	0	1	2	3	4	5	6	7	8
	DLE	STX	Device Address	CMD	In/Out	Channel	No/Yes	STX	DLE
Packet	0x7B	0x7D	1~254	0x42	In:0 Out:1	00~15	No:0 Yes:1	0x7D	0x7B

范例 (不静音Out1) : 7B7D01420100007D7B

(4) 调用预设 (0x43)

	0	1	2	3	4	5	6	7	8
	DLE	STX	Device Address	CMD	Factory/User	Preset	0x00	STX	DLE
Packet	0x7B	0x7D	1~254	0x43	F: 0, U: 1	0~12	0	0x7D	0x7B

范例 (调用用户预设U01) : 7B7D01430100007D7B

EKX-808数字矩阵处理器

(5) 输入音量控制 (0x44)

	0	1	2	3	4	5	6	7	8
	DLE	STX	Device Address	CMD	Channel	HI-VOL	LO-VOL	STX	DLE
Packet	0x7B	0x7D	1~254	0x44	00~15	0x??	0x??	0x7D	0x7B

范例 (In1音量+0.0dB) : 7B7D01440001187D7B

(6) 输出音量控制 (0x45)

	0	1	2	3	4	5	6	7	8
	DLE	STX	Device Address	CMD	Channel	HI-VOL	LO-VOL	STX	DLE
Packet	0x7B	0x7D	1~254	0x45	00~15	0x??	0x??	0x7D	0x7B

范例 (Out2音量-3.0dB) : 7B7D01450100FA7D7B

(7) 编组音量控制(0x46)

	0	1	2	3	4	5	6	7	8
	DLE	STX	Device Address	CMD	In/Out	Gain	0x00	STX	DLE
Packet	0x7B	0x7D	1~254	0x46	In:0 Out:1	0~100	0	0x7D	0x7B

范例 (输入编组音量90%) : 7B7D0146005A007D7B

(8) 编组增益控制(0x47)

	0	1	2	3	4	5	6	7	8
	DLE	STX	Device Address	CMD	In/Out	+/-	0x00	STX	DLE
Packet	0x7B	0x7D	1~254	0x47	In:0 Out:1	+: 0, -: 1	0	0x7D	0x7B

范例 (提升输入编组增益) : 7B7D01470000007D7B

(9) 读取增益码值(0x48)

	0	1	2	3	4	5	6	7	8
	DLE	STX	Device Address	CMD	In/Out	Channel	0x00	STX	DLE
Packet	0x7B	0x7D	1~254	0x48	In:0 Out:1	00~15	0	0x7D	0x7B

MCU Return: 1st Byte: In/Out, 2nd Byte = Channel, 3rd Byte: 0-80(-60~-20): 0.5dB/Step,80-280(-20~0): 0.1dB/Step, 280-400(0~+12): 0.1dB/Step

范例(读取In1音量参数) : 7B7D01480000007D7B

EKX-808数字矩阵处理器

(10) 读取静音码值(0x49)

	0	1	2	3	4	5	6	7	8
	DLE	STX	Device Address	CMD	In/Out	Channel	0x00	STX	DLE
Packet	0x7B	0x7D	1~254	0x49	In:0, Out:1	00~15	0	0x7D	0x7B

MCU Return: 1st Byte: In/Out, 2nd Byte = Channel, 3rd Byte: 0x00 or 0x01 = Un-Mute or Mute

范例（读取In1静音参数）：7B7D01490000007D7B

(11) 读取预设码值(0x4A)

	0	1	2	3	4	5	6	7	8
	DLE	STX	Device Address	CMD	0x30	0x00	0x00	STX	DLE
Packet	0x7B	0x7D	1~254	0x4A	0	0	0	0x7D	0x7B

MCU Return: 0x00 ~ 0x0C = 0: F00, 1~12: U01~U12

范例（读取预设参数）：7B7D014A0000007D7B

(12) 读取编组码值(0x4B)

	0	1	2	3	4	5	6	7	8
	DLE	STX	Device Address	CMD	In/Out	0x00	0x00	STX	DLE
Packet	0x7B	0x7D	1~254	0x4B	In:0 Out:1	0	0	0x7D	0x7B

MCU Return: 1st Byte: 0 ~ 100%, 2nd Byte = 0x00 or 0x01 = Un-Mute or Mute

范例（读取输入编组参数）：7B7D014B0000007D7B

(13) 编组静音控制(0x4C)

	0	1	2	3	4	5	6	7	8
	DLE	STX	Device Address	CMD	In/Out	No/Yes	0x00	STX	DLE
Packet	0x7B	0x7D	1~254	0x4C	In:0 Out:1	No:0, Yes:1	0	0x7D	0x7B

范例（输出静音）：7B7D014C0101007D7B

EKX-808数字矩阵处理器

(14) 读取电平值(0x4D)

	0	1	2	3	4	5	6	7	8
	DLE	STX	Device Address	CMD	In/Out	Channel	0x00	STX	DLE
Packet	0x7B	0x7D	1~254	0x4D	In: 0, Out: 1 Aux: 2	00~15	0	0x7D	0x7B

MCU Return: 1st Byte: In/Out, 2nd Byte = Channel, 3rd Byte: -128 ~ -1, 0 ~ +127dB = 0x80 ~ 0xFF, 0x00 ~ 0x7F

范例（读取In1电平值）：7B7D014D0000007D7B

范例（读取Out1电平值）：7B7D014D0100007D7B

范例（读取Aux电平值）：7B7D014D0200007D7B

(15) 矩阵控制(0x4E)

	0	1	2	3	4	5	6	7	8
	DLE	STX	Device Address	CMD	Channel	In	On/Off	STX	DLE
Packet	0x7B	0x7D	1~254	0x4E	00~15	00~15	On: 1 Off: 0	0x7D	0x7B

范例（Out4矩阵In2开）：7B7D014E0301017D7B

(16) 读取矩阵码值(0x4F)

	0	1	2	3	4	5	6	7	8
	DLE	STX	Device Address	CMD	Channel	In	0x00	STX	DLE
Packet	0x7B	0x7D	1~254	0x4F	00~15	00~15	0	0x7D	0x7B

MCU Return: 0x00 or 0x01 = Off or On

范例（读取Out3矩阵In3参数）：7B7D014F0202007D7B

(17) Aux增益控制(0x51)

	0	1	2	3	4	5	6	7	8
	DLE	STX	Device Address	CMD	Aux	0x00	+/-	STX	DLE
Packet	0x7B	0x7D	1~254	0x51	0x02	0x00	+:0,-:1	0x7D	0x7B

范例（提升Aux增益）：7B7D01510200007D7B

EKX-808数字矩阵处理器

(18) Aux静音控制(0x52)

	0	1	2	3	4	5	6	7	8
	DLE	STX	Device Address	CMD	Aux	0x00	No/Yes	STX	DLE
Packet	0x7B	0x7D	1~254	0x52	0x02	0x00	No:0,Yes:1	0x7D	0x7B

范例 (Aux 静音) : 7B7D01520200017D7B

(19) Aux音量控制(0x53)

	0	1	2	3	4	5	6	7	8
	DLE	STX	Device Address	CMD	Aux	HI-VOL	HI-VOL	STX	DLE
Packet	0x7B	0x7D	1~254	0x53	0x02	0x??	0x??	0x7D	0x7B

范例 (音量 +0.0dB) : 7B7D01530201187D7B

(20) 音量增减(0x54)

	0	1	2	3	4	5	6	7	8
	DLE	STX	Device Address	CMD	In/Out	Channel	+/-	STX	DLE
Packet	0x7B	0x7D	1~254	0x54	In:0, Out:1	00~15	+:0, -:1	0x7D	0x7B

-60dB~-20dB: 2dB/Step, -20dB~+12dB: 1dB/Step

范例(In1音量增加): 7B7D01540000007D7B

(21) 辅助开关控制(0x55)

	0	1	2	3	4	5	6	7	8
	DLE	STX	Device Address	CMD	0x02	Select	On/Off	STX	DLE
Packet	0x7B	0x7D	1~254	0x55	0x02	0: effect 1: Camera 2: AutoMix 3: AEC 4: NR	0:Off 1:Yes	0x7D	0x7B

范例 (效果开) : 7B7D01550200017D7B

范例 (摄像头开) : 7B7D01550201017D7B

范例 (自动混音开) : 7B7D01550202017D7B

范例 (回升消除开) : 7B7D01550203017D7B

范例 (降噪开) : 7B7D01550204017D7B

EKX-808数字矩阵处理器

(22) Aux输入选择控制(0x56)

	0	1	2	3	4	5	6	7	8
	DLE	STX	Device Address	CMD	Select	Ch 16~9	Ch 8~1	STX	DLE
Packet	0x7B	0x7D	1~254	0x56	0: AUX 1: Camera 2: Auto Mix	Bit0 ~Bit7: 0:No 1:Yes	Bit0 ~Bit7: 0:No 1:Yes	0x7D	0x7B

范例 (AUX输入In1&In3) : 7B7D01560000057D7B

范例 (摄像头输入In2&In4) : 7B7D015601000A7D7B

范例 (自动混音输入In5&In6) : 7B7D01560200307D7B

(23) 输入反馈控制(0x57)

	0	1	2	3	4	5	6	7	8
	DLE	STX	Device Address	CMD	0X00	Channel	FBQ	STX	DLE
Packet	0x7B	0x7D	1~254	0x57	0X00	00~15	0:OFF, 1~4: Level	0x7D	0x7B

范例 (In3反馈Level3) : 7B7D01570002037D7B

(24) 读取Aux增益码值(0x58)

	0	1	2	3	4	5	6	7	8
	DLE	STX	Device Address	CMD	Aux	0x00	0x00	STX	DLE
Packet	0x7B	0x7D	1~254	0x58	0x02	0x00	0x00	0x7D	0x7B

MCU Return: 1st Byte: Aux/Effect, 2nd and 3rd Byte: 0-80(-60~-20): 0.5dB/Step, 80-280(-20~0):

0.1dB/Step, 280-400 (0~+12):0.1dB/Step

范例 (读取Aux音量参数) : 7B7D01580200007D7B

(25) 读取Aux静音码值(0x59)

	0	1	2	3	4	5	6	7	8
	DLE	STX	Device Address	CMD	Aux	0x00	0x00	STX	DLE
Packet	0x7B	0x7D	1~254	0x59	0x02	0x00	0x00	0x7D	0x7B

MCU Return: 1st Byte: Aux/Effect, 2nd Byte: 0x00 or 0x01 = Un-Mute or Mute

范例 (读取Aux静音参数) : 7B7D01590200007D7B

EKX-808数字矩阵处理器

(26) 读取辅助开关码值(0x5B)

	0	1	2	3	4	5	6	7	8
	DLE	STX	Device Address	CMD	0x02	Select	0x00	STX	DLE
Packet	0x7B	0x7D	1~254	0x5B	0x02	0: effect 1: Camera 2: AutoMix 3: AEC 4: NR	0x00	0x7D	0x7B

MCU Return: 1st Byte: Select, 2nd Byte: 0x00 or 0x01 = On or Off

范例（读取效果开关参数）：7B7D015B0200007D7B

范例（读取Aux摄像头开关参数）：7B7D015B0201007D7B

范例（读取Aux自动混音开关参数）：7B7D015B0202007D7B

范例（读取Aux回升消除开关参数）：7B7D015B0203007D7B

范例（读取Aux降噪开关参数）：7B7D015B0204007D7B

(27) 读取Aux输入选择码值(0x5C)

	0	1	2	3	4	5	6	7	8
	DLE	STX	Device Address	CMD	0x02	Select	0x00	STX	DLE
Packet	0x7B	0x7D	1~254	0x5C	0x02	0: AUX 1: Camera 2: AutoMix	0x00	0x7D	0x7B

MCU Return: 1st Byte: Select, 2nd Byte: Matrix

范例（读取Aux输入选择参数）：7B7D015C0200007D7B

(28) 读取反馈抑制码值(0x5E)

	0	1	2	3	4	5	6	7	8
	DLE	STX	Device Address	CMD	0x00	Channel	FBQ	STX	DLE
Packet	0x7B	0x7D	1~254	0x5E	0x00	0~15	0: off 1~4: Level	0x7D	0x7B

MCU Return: 1st Byte: Channel, 2nd Byte = Level

范例（读取In5反馈抑制参数）：7B7D015E0004007D7B

EKX-808数字矩阵处理器

(29) 读取全矩阵码值(0x61)

	0	1	2	3	4	5	6	7	8
	DLE	STX	Device Address	CMD	0x00	0x00	0x00	STX	DLE
Packet	0x7B	0x7D	1~254	0x61	0x00	0x00	0x00	0x7D	0x7B

MCU Return: 1st Byte: Channel, 2nd Byte = Matrix, total 5 x 32 = 160 Bytes

范例（读取全矩阵码参数）：7B7D01610000007D7B

(30) 读取群组参数(0x63)

	0	1	2	3	4	5	6	7	8
	DLE	STX	Device Address	CMD	Group In1 Group Out4	0x00	0x00	STX	DLE
Packet	0x7B	0x7D	1~254	0x63	0~7	0x00	0x00	0x7D	0x7B

MCU Return: 1st Byte: Channel, 2nd Byte: Volume, 3rd Byte: Mute, 4th Byte = Matrix, total 2 Bytes

范例（读取群组参数）：7B7D01630000007D7B

(31) 群组音量控制(0x66)

	0	1	2	3	4	5	6	7	8
	DLE	STX	Device Address	CMD	Group In1 Group Out4	Gain	0x00	STX	DLE
Packet	0x7B	0x7D	1~254	0x66	0~7	0~100	0	0x7D	0x7B

范例(输入群组2音量90%)：7B7D0166015A007D7B

(32) 群组增益控制(0x67)

	0	1	2	3	4	5	6	7	8
	DLE	STX	Device Address	CMD	Group In1 Group Out4	+/-	0x00	STX	DLE
Packet	0x7B	0x7D	1~254	0x67	0~7	+:0, -:1	0	0x7D	0x7B

范例（提升输出群组3编组递增）：7B7D01670600007D7B

EKX-808 数字矩阵处理器

(33) 群组静音控制(0x68)

	0	1	2	3	4	5	6	7	8
	DLE	STX	Device Address	CMD	Group In1 Group Out4	No/Yes	0x00	STX	DLE
Packet	0x7B	0x7D	1~254	0x68	0~7	No: 0, Yes: 1	0	0x7D	0x7B

范例（输出群组4静音）：7B7D01680701007D7B

(34) 群组输入1-16选择控制(0x69)

	0	1	2	3	4	5	6	7	8
	DLE	STX	Device Address	CMD	Group In1 Group Out4	Ch 16~9	Ch 8~1	STX	DLE
Packet	0x7B	0x7D	1~254	0x69	0~7	Bit0~Bit7: 0:No 1:Yes	Bit0~Bit7: 0:No 1:Yes	0x7D	0x7B

范例（输入群组3 In11&In13）：7B7D01690214007D7B

MCU接收到正确控制代码时回覆OK: 0x4F 0x4B

Communicate Paramete	Baud Rate	115200	Stop Bit	1
	Data Bit	8	Step	>=200ms
	Parity	None	ID	Default1

EKX-808 数字矩阵处理器

使用安全事项

[使用该产品前,请仔细阅读以下安全事项:]

● 本产品应做到可靠的接地,如出现故障时,为避免电击,本机电源线及电源插头都配备安全接地,电源线应按安规要求安装和接地。

注意! 接地装置连接不当会导致电击。

如果你对本产品是否正确接地有任何疑问,请委托合格电工或专业维修人员检查,请不要尝试私自更改产品的电源插头,如果电源插有不合适,可委托合格电工或专业维修人员安装适当的电源插座。

● 为了避免伤害的风险,当产品在小孩附近使用时,请严密监管。

● 请勿在湿度很大的地方使用本机器,例如:靠近浴缸、洗面盆、厨房水池、湿度很大的地下室或靠近游泳池和湖泊等地方。

● 设备上不得放置诸如花瓶一类的装满液体的物品。

● 该产品应当安装在通风良好,环境干燥的地方。

● 该产品的电源类型必须符合操作指示或产品上标明的类型。

● 该产品必须远离热源,例如:电暖气、电热毯、或其他产生热源的产品。

● 该产品配备一条符合安全认证要求的电源线,如果你无法把电源插头插入电源插座,请联系电工或专业维修人员来更换旧的插座.请勿破坏电源插头的安全装置。

● 该产品长时间不使用时,请把电源线从电源插座中拔出,从电源插座拔出电源线时,请勿拉扯电源线,应当抓住

● 本产品使用开关做为断接装置, 应该保持方便操作。

● 当有下列情况发生时,请委托合格电工或专业维修人员修理:

A. 电源线或电源插头已经损坏。

B. 杂物或液体物质侵入机箱内。

C. 产品已经被淋雨。

D. 产品已经不能正常操作或在演出时出现明显变化。

E. 产品跌坏或外观已经损坏

● 当出现不属于用户维修指南中描述的情况时,请勿尝试自行修理,应当委托合格的电工或专业维修人员修理。

● 本产品仅适用于海拔2000m以下地区使用。



● 本产品仅适用于非热带气候条件下安全使用。



注意在产品内部存在非绝缘的危险电压,有可能对人体造成相当的伤害。



在产品附带的说明书中存在重要操作说明和维护指南。



注意
为避免受到电击
请勿开启



小心:为避免受到电击,请勿私自移开(底)盖,如遇到问题亦不要尝试私自修理,请委托专业维修人员修理。

警告!

请勿让重物挤压或踩踏电源线,切忌拉、拔或强力扭曲电源线。请勿滥用不合格的电源线,以免导致引起火灾或对人体造成伤害。

EKX-808 Digital Matrix Processor

Functions

- 32 bit DSP, 96kHz sampling rate, 24bit AD/DA.
- +48V phantom power, MIC/LINE input gain switchable, MIC input sensitivity adjustable.
- Input including, high-cut, low-cut, PEQ, independent feedback inhibition, noise gate, gain, mute, phase, delay, link.
- Output including X-over, PEQ, Gain, mute, compressor/limiter, phase, delay and link.
- All PEQ Gain, bandwidth, frequency continues adjustment. type can be select by PEAK, H-SHELF, L- SHELF, LOW CUT, HIGH CUT, ALLPASS1, ALLPASS2.
- All inputs/outputs can do Matrix, and all the input and output channel name can be changed.
- All the input and output with independent phase curve adjust function, PEQ style choose ALLPASS1 is 180° curve adjust, ALLPASS2 is 360° curve adjust.
- All high cut, low-cut filter type can be select by Butterworth, Link witz-Riley, Bessel, slope can be chosen.
- Noise gate's threshold, time, ratio can be adjustment for inputs, compressor, limiter, ratio, time can be adjustment for outputs.
- Maximal delay time 680mS for all output channels.
- Pre settings can copy for every single channel, every channel can do link adjust.
- Every input and output channel PEQ curve adjusting picture can be found when you are in any input and output.
- Unique design for AUX channels, mixing all microphone inputs, and professional ECHO & REVERB effects inside. easy adjustment the sound and full support karaoke function. wide-applications, such as conference system, multi-functions hall. etc...
- AUX channel has powerful mixing function, such as threshold, level, attack time. release time, continually adjustment. also with the automatic function of camera-tracking. threshold, level, attack&release time. etc... AEC automatic echo cancellation and system environment noise cancellation function, effectively reducing the pickup of the speakers and the terrible echo which caused by the reflection of wall. It can also eliminate environmental noise that generated by the feedback of pickup, moreover the noise of air conditioner and fan, and independent PEQ, compressor, volume adjustment functions.
- Inside single generator (pink, white noise and 20~20K sine wave, amplitude adjustable).
- Front panel has level indicator for input/output, USB port, RS232, 485 and net ports remote control at rear panel. easy for user's operations.
- 21 user presets can be save and recall, maximal 255 units can be link together via ID settings. password protection function for high level applications.

Front Panel

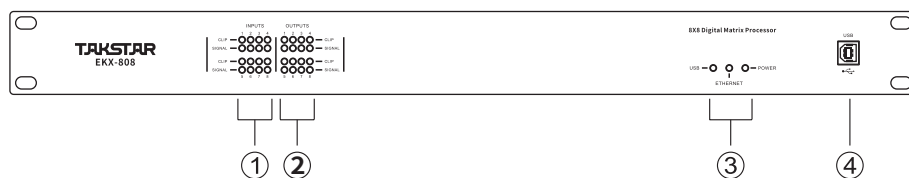

1. INPUT CHANNEL LEVEL INDICATORS

2 segment high precision level indicate lights show the current input channel level status.

2. OUTPUT CHANNEL LEVEL INDICATORS

2 segment high precision level indicate lights show the current output channel level status.

3. WORKING STATUS

USB, internet connection signal and power indicate lights.

4. USB INTERFACE

Used to connect with PC and center-control equipment, remote control.

EKX-808 Digital Matrix Processor

Rear Panel

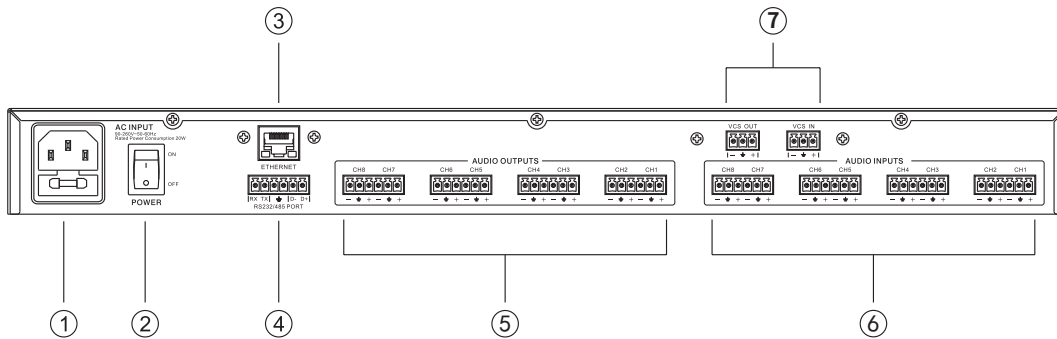

1. POWER SOCKET

AC~95-264V 50-60Hz.

2. POWER SWITCH

3. ETHERNET CONNECTION AND CONTROLLING PORT

Setting IP addresses to remote control by CAT-5 cable or WIFI control, also support internet control for long-distance application.

4. RS232/485

Realize remote real-time control of center-control device through Rs232, or control by one USB cord, link control by RS485.

5. SIGNAL OUTPUT CH1~CH8

6. SIGNAL INPUT CH1~CH8

7. AEC far IN and far OUT port

VCS IN is the input port for signals sent from the far port, and VCS OUT is the signal interface for signals sent to the far port.

PC Software

NOTICE: User manual, PC software are on the attached CD, due to the software upgrades time by time, please do control your DSP processor ONLY by this CD!

USB CONNECTION STEPS

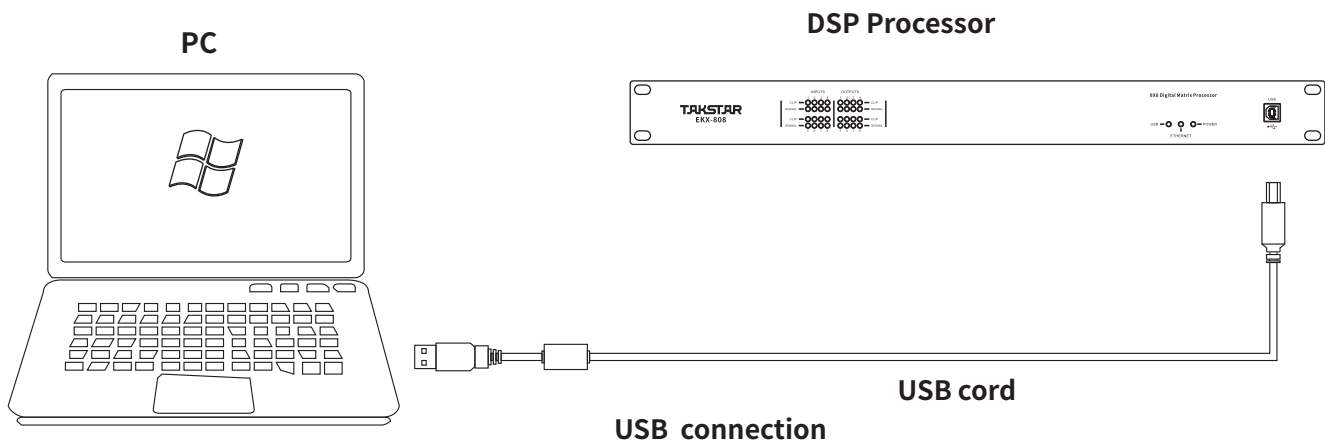

EKX-808 Digital Matrix Processor

1. Click the PC software on the CD, press next step to continue according to the instruction until finish setup, then exit.

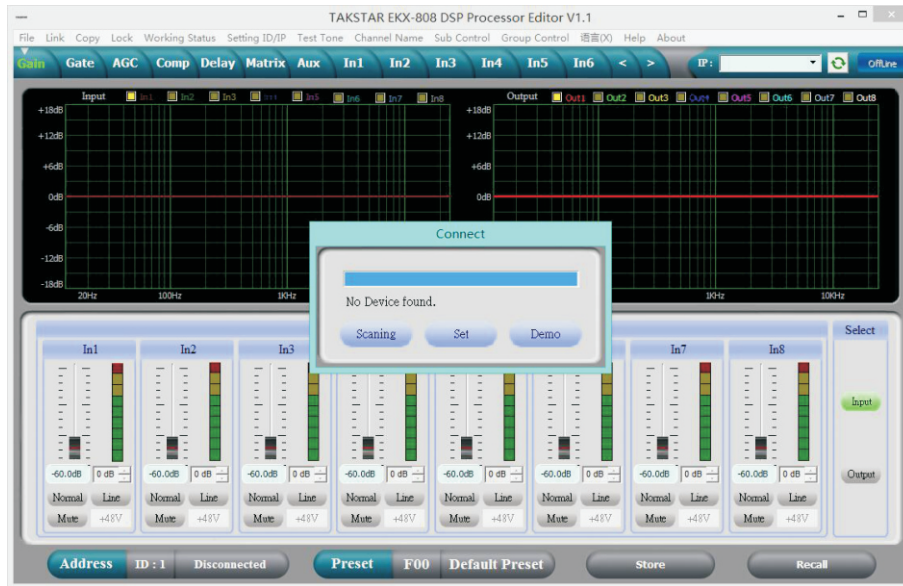

2. Connect the processor to the computer by USB, after power on the device, the computer will searching new hardware automatically, then it will show the message: hardware setup success and can be used.

3. Open PC controlling software, PC software will find USB and connection device, after this the on-line key change into green at the top right corner and show " Online " , you can operate the processor by controlling software, Click " Online" button before exit.

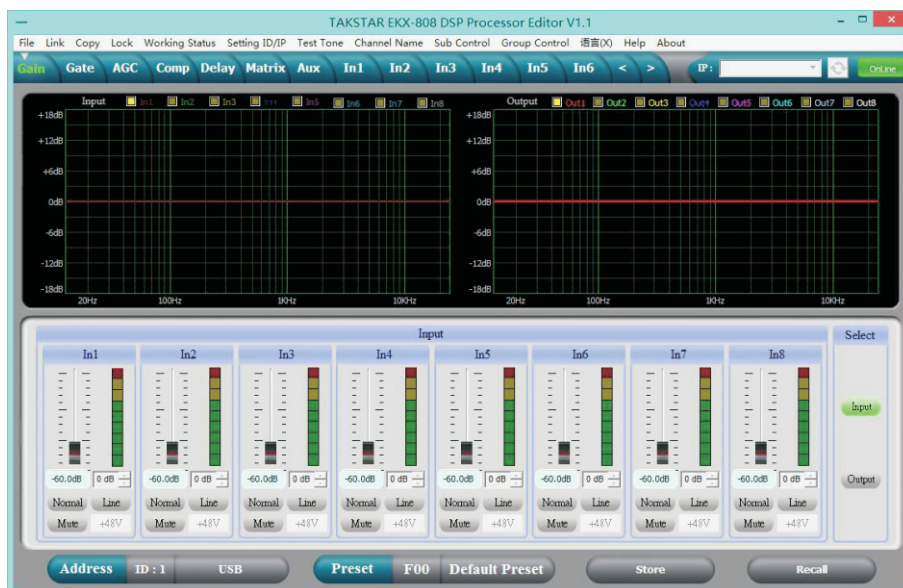

EKX-808 Digital Matrix Processor

PC Software Specifications

(1). VOLUME CONTROLLING INTERFACE



1. Menu

File	Open and save preset parameter, the whole date upload to the computer and download to the device.
Link	Input and output channels can be set freely to adjust all of the parameter sad are.
Copy	Parameter copy freely between the input and Output channels.
Lock	Setting password of the panel to ensure the safety of the device.
Working Status	The working atatus could be set as; not memory ; immediate memory (under U01-21 user mode) , not memory but can be back to U01 mode when power on.
Setting ID/IP	To cascade control more than 254 device by setting different ID Setting IP address for Long-distance and wireless WIFI control.
Test Tone	Buid-in signal generator, outputting pink noise, white noise and sine wave
Channel Name	The whole channel name are revisable.
Sub Control	Any channel volume are revisable.
Group Control	Independent input and output 4 group control, can control different areas through the wall panel.
Language	Chinese and English language is switchable.

2. Spectrum Area: You can choose PEQ and phase freely which show the input and output channels.

EKX-808 Digital Matrix Processor

3. The Volume Control Area:

Gain, Phase, Mute control for all input & output channels.

4. Preset Operation Area:

Save or recall preset parameter and show current preset parameter status.

(2). NOISE GATE INTERFACE

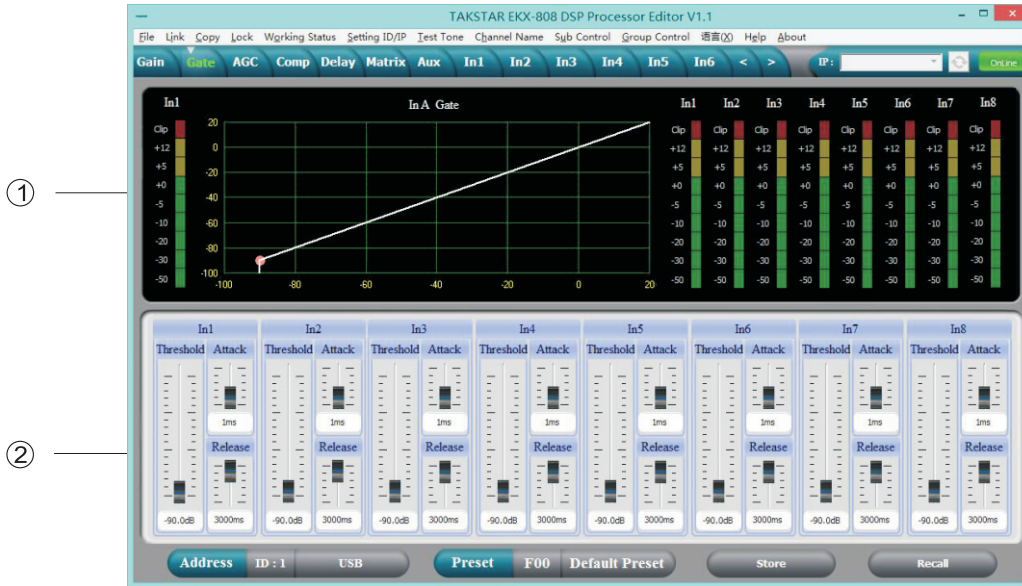

1. Show threshold curve, level indicators and compression status for all channels.

2. Setting noise gate parameters for all input channels, the threshold is -90dB--20dB, start Time is: 1- 999ms, recovery time is 1-3000ms.

(3). AGC CONTROL INTERFACE

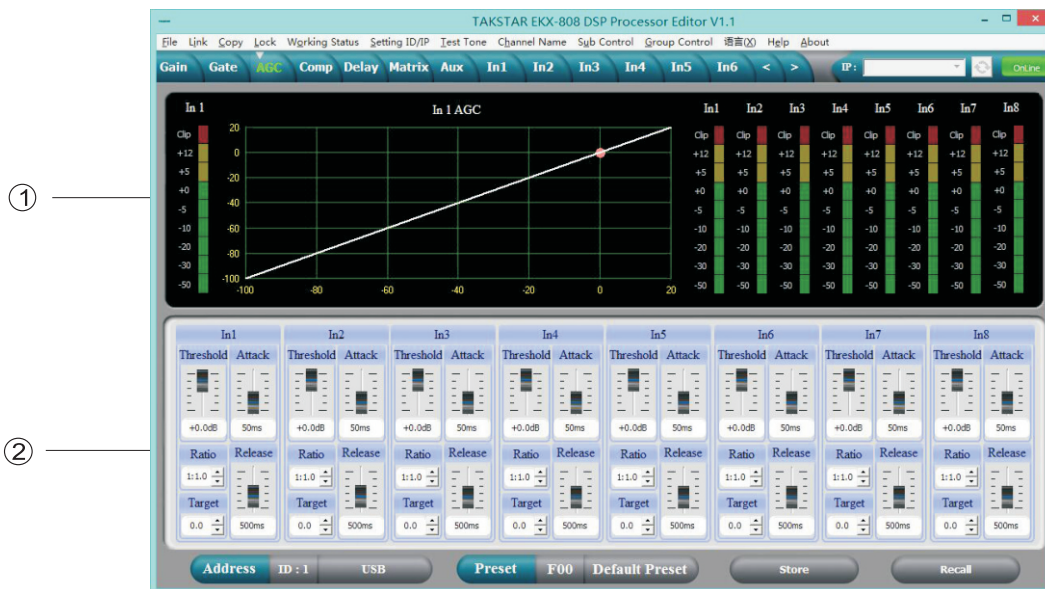

1. Graph showing automatic gain changes and level indicator lights for all channels.

2. AGC control parameters of all input channels can be set: threshold value -60dB to 0dB, target level -60dB to 0dB, attack time 1-999ms, recovery time 10-3000ms, ratio 1:1.0-1:20-limit continuously adjustable.

EKX-808 Digital Matrix Processor

(4). COMPRESSOR INTERFACE

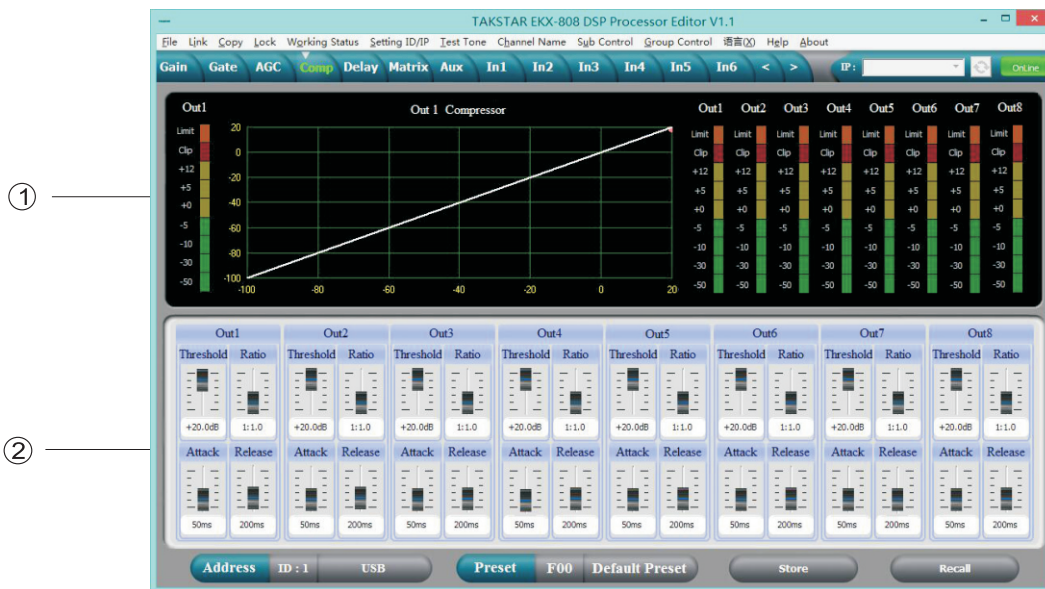

1. Show compression status level indicators and compression status of all channels.
2. Set the whole compression parameters for output channels, the compression range is -60dB--+20dB, ration is 1:1, 1:10, LIMIT, start time is: 1-999ms, recovery time is 1-3000ms.

(4). DELAY INTERFACE

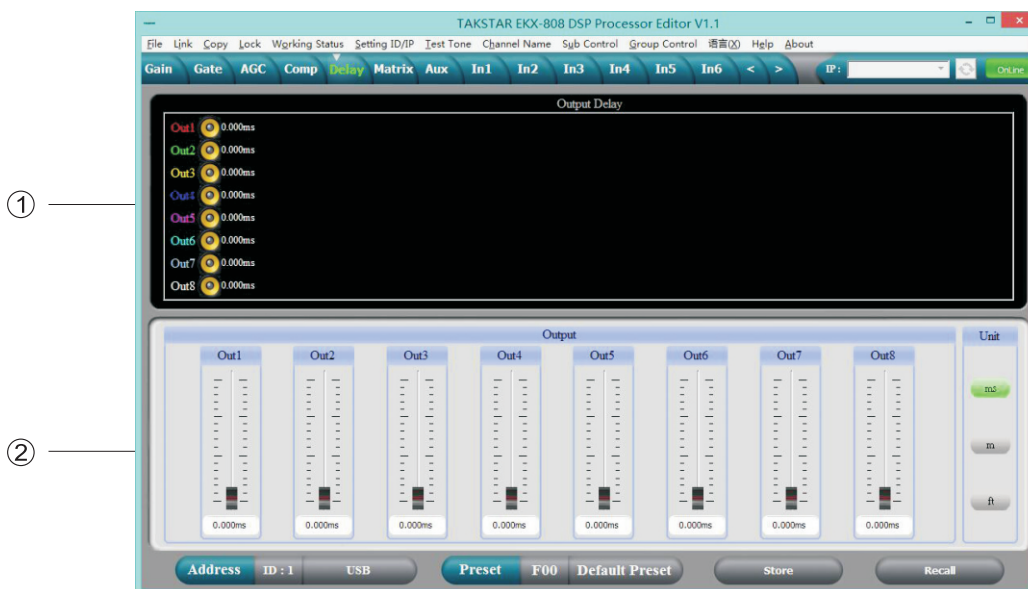

1. Show the delay parameter status of all channels.
2. Can adjust delay parameter of all channels, the scale is 0-680ms , there are millisecond, meter and feet units for choose.

EKX-808 Digital Matrix Processor

(6). MATRIX INTERFACE



1. Show connections of the device, users can enter and edit relevant channel by clicking the square button, every channel name is revisable.

2. All output channels can choose any input channels.

EKX-808 Digital Matrix Processor

(7). AUX CHANNEL INTERFACE

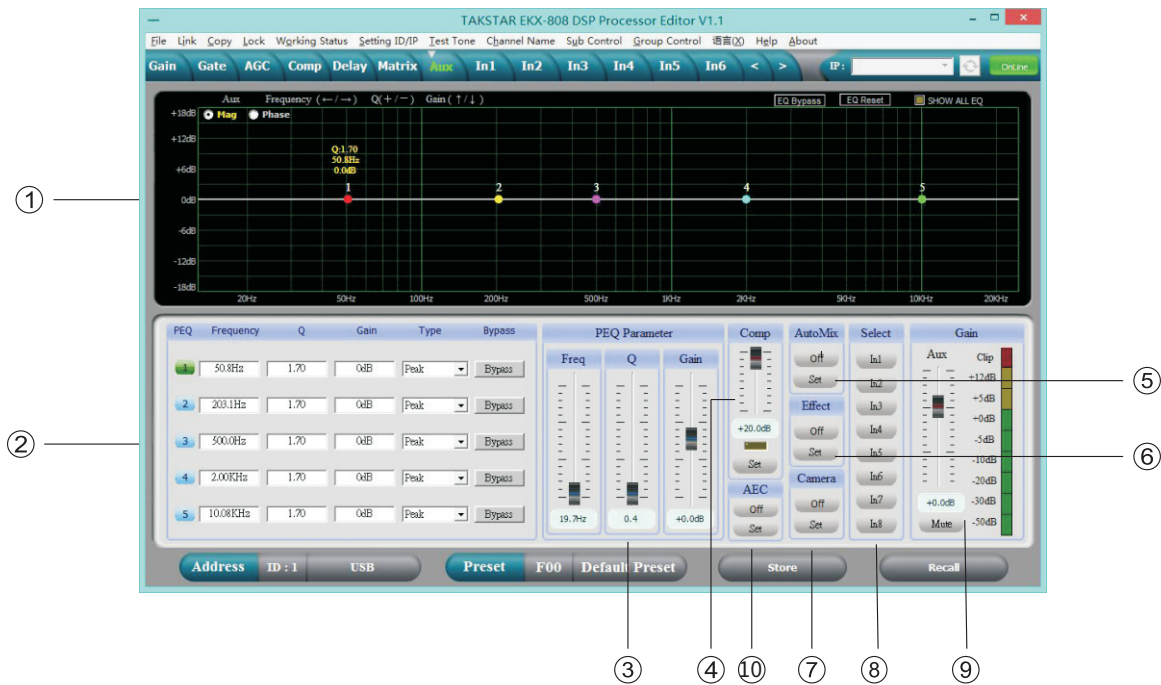

1. Select " Mag" interface, you can adjust the PEQ, High-cut and Low-cut parameters, select " PHASE" Interface, you can adjust the phase curve, also you can choose the non-current channel' s PEQ And phase curve to show in sync.
2. Adjustable Gain, Q, Frequency and Type for all PEQs, Bypass function is an option, we can choose PEQ style: Balance, High-shelf, Low-shelf, High-cut, Low-cut, Phase 180° or 360° of phase.
3. The Gain, Q, Frequency of PEQ can be adjusted by fader, and can be controlled by pressing theUp, Down, Left, Right key on the computer's keyboard.
4. With compression adjusting fader on Aux channel, click" Set " button , enter compression parameters setting: the compression range is: -90dB- +20dB,ratios is :1:1, 1:10,LIMIT,start time:0-999ms, recovery time: 0-999ms, the compression indicators be showed too.
5. Auto-mixing ON/OFF switch, click "Set" button, enter auto-mixing parameters setting: choose The input channel which want to enter the auto audio mixing first(only the chosen channel can enter automixing channel),then choose the proper parameters of threshold(-50-0dB), start time(0-5000ms), recovery time (0-5000ms). The several channels can enter auto-mixing status when any more than 2 channels signal are over the threshold, aux channel's volume comes down when more channels get into the mixing channel.
6. Aux channels effect switch, click "Set" button, enter effect parameters setting, adjustable echo parameters for volume, repeat, delay, pre-delay.Adjustable reverb volume parameters for volume, reflect, time, pre-delay.and with a adjustment fader for whole effect of volume.
7. Camera tracking ON/OFF switch, click"Set"button,enter camera tracking parameters setting: choose the corresponding input channel which want to enter the camera tracking first(only the Chosen channel can enter to tracking channel),then choose the proper parameters of threshold (-50-0dB), start time (0-5000ms),recovery time(0-5000ms), when the any one channel signal is over the threshold, the channel will open automatically and camera start to track according to the Priority order from input ch A~ ch H.
8. Input selection fader, can choose the input 1-8 channels to mix in Aux channels.
9. Aux's Gain controlling fader, mute&level indicators.
10. ECHO cancellation ON/OFF, Click the "Set" key to enter the interface of echo cancellation volume control and noise reduction function. The microphone of echo cancellation input volume, and the far in and far out volume can be adjusted independently. Note that the local microphone volume is about the same as the far IN signal volume when used, so that the effect is best, and the VCS IN and AEC OUT volume can be adjusted appropriately for optimal handling IN different environments. NR noise reduction function is optional at 6-15dB. Note that there will be a certain delay after opening NR.

EKX-808 Digital Matrix Processor

(8). INPUT INTERFACE



1. Select "Mag" interface, you can adjust the PEQ, High-cut, Low-Cut for the input channel, select "PHASE" interface, you can adjust the current phase channel, also you can choose the non-current PEQ and phase curve to show in sync.
2. Adjustable Gain, Mute, Q, Frequency, Type for all PEQ, Bypass function is an option, we can choose PEQ style: Balance, High-shelf, Low-shelf, High-cut, Low-cut, 180° or 360° of phase.
3. The Gain, Q, Frequency of PEQ can be adjusted by fader, and can be controlled by pressing the Up, Down, Left, Right key on the computer's keyboard.
4. Low-cut frequency 20HZ-20KHZ is adjustable, you can choose slope rate: Butterworth, Bessel, the scale is: -6dB- -48dB.
5. High-cut frequency 20HZ-20KHZ is adjustable, you can choose slope rate: Butterworth, Bessel, the scale is: -6dB- -48dB.
6. Input can select the level of feedback inhibition, level 1-4 can be chosen.
7. The Gain, Mute, Phase of the input channels can be control separately, as same as the level display lights.

EKX-808 Digital Matrix Processor

(9). OUTPUT INTERFACE

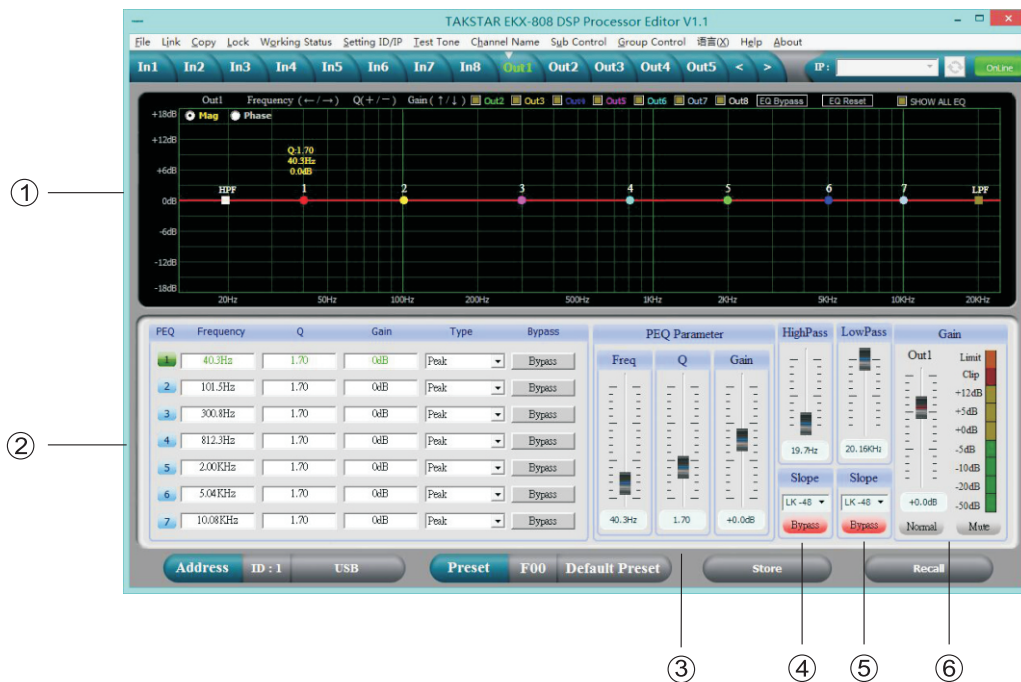

1. Select “Mag” interface, you can adjust the PEQ, High-cut, Low-Cut for the output channels, select “PHASE” interface, you can adjust the current phase channel, also you can choose the non- current PEQ and phase curve to show in sync.
2. Adjustable Gain, Mute, Q, Frequency, Type of all PEQ, Bypass function is an option, we can choose PEQ style: Balance, High-shelf, Low-shelf, High-cut, Low-cut, Phase 180°, 360° of phase.
3. The gain, Q, frequency of PEQ can be adjusted by fader, and can be controlled by pressing the up, down, Left, Right key on the computer's keyboard.
4. Low-cut frequency 20HZ-20KHZ is adjustable, you can choose slope rate: Butterworth, Bessel, Linkwitz-Riley, the scale is: -6dB- -48dB.
5. High-cut frequency 20HZ-20KHZ is adjustable, you can choose slope rate: Butterworth, Bessel, the scale is: -6dB- -48dB.
6. The Gain, Mute, Phase of the output channels can be control separately, as same as the level Display, lights.

EKX-808 Digital Matrix Processor

Specifications

SPEC	Frequency Response	20Hz-20kHz,-0.3dB
	Dynamic range	115dBu
	THD	<0.005% at 1kHz(0dBu)
	Crosstalk	>70dBu, 20Hz-20kHz
	C.M.R.R	>75dBu 1KHz
MIC input	Type	Balance
	Phantom power	+48V DC
	Gain	50dBu
	Impedance	2k ohm
Music input	Type	Balance
	Gain	35dBu
	Max input level	+18dBu
	Impedance	>10k ohm
Output	Type	Balance
	Max output level	+18dBu
	Impedance	<500Ω
Digital processing	24bit sigma-delta A/D、D/A	
	32 bit DSP, 96kHz	
AC POWER	AC 95V-264V 50/60Hz	
Size(L,W,H)	482*254*44MM	
Weight	2.7KG	

Accessories

1. CD (Include PC software and user's manual).
2. One USB cord.
3. One Power cord.

EKX-808 Digital Matrix Processor

Rear panel control port connection

1. Ethernet connection port: you can choose to connect the computer by wire, connect several devices by switch, or use WIFI by router to control, but need to set different IP address and ID code for each device, otherwise, it might be can't connect successfully due to the IP addresses conflict.

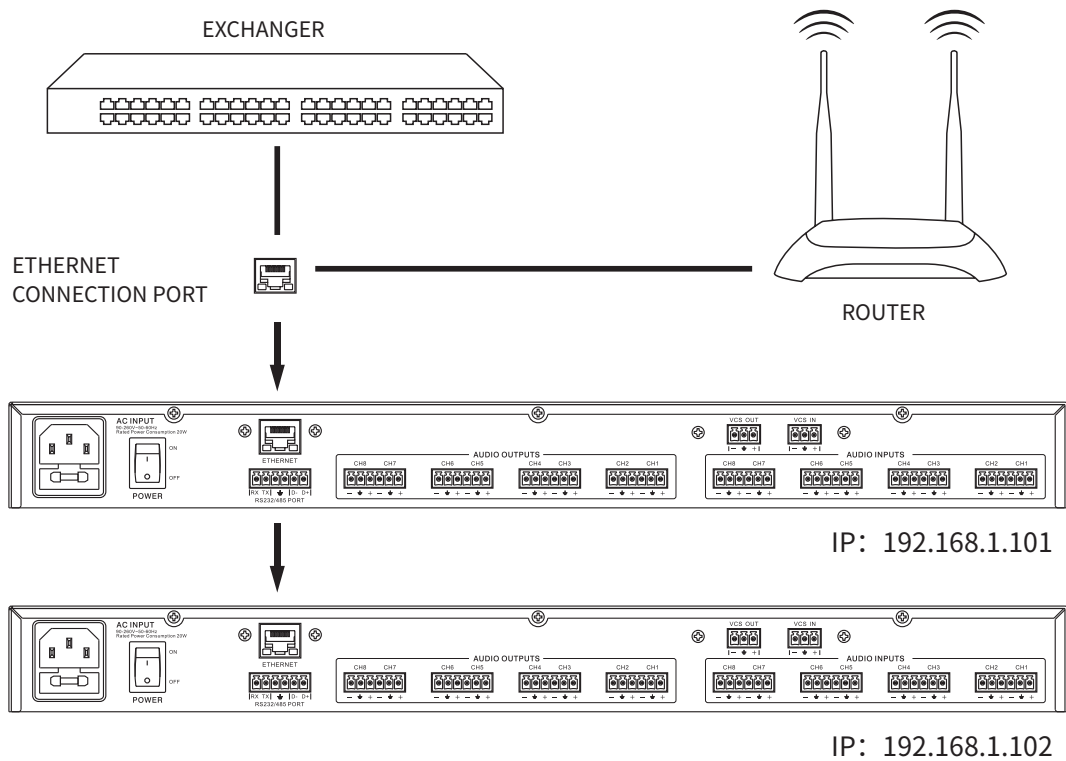

2. RS232 connection port: Central control and connect to PC through RS232 port.

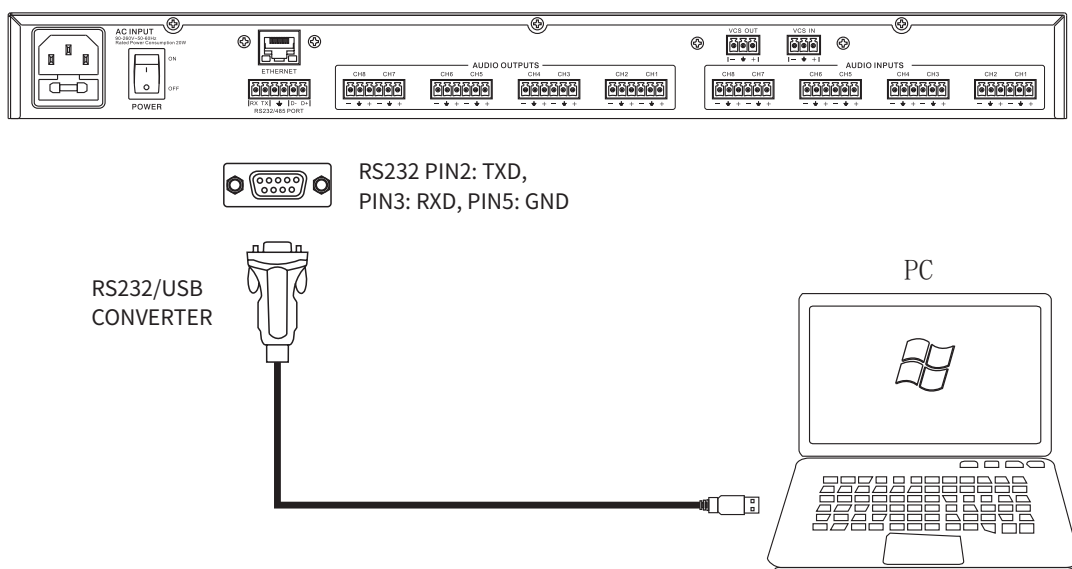

EKX-808 Digital Matrix Processor

3. RS485 cascade control port: link connect several devices by RS485 you can choose different ID to control separately
 Connect multiple devices 480 port D+ and D- together can cascade control for multiple machines after setting the machine with different ID Numbers

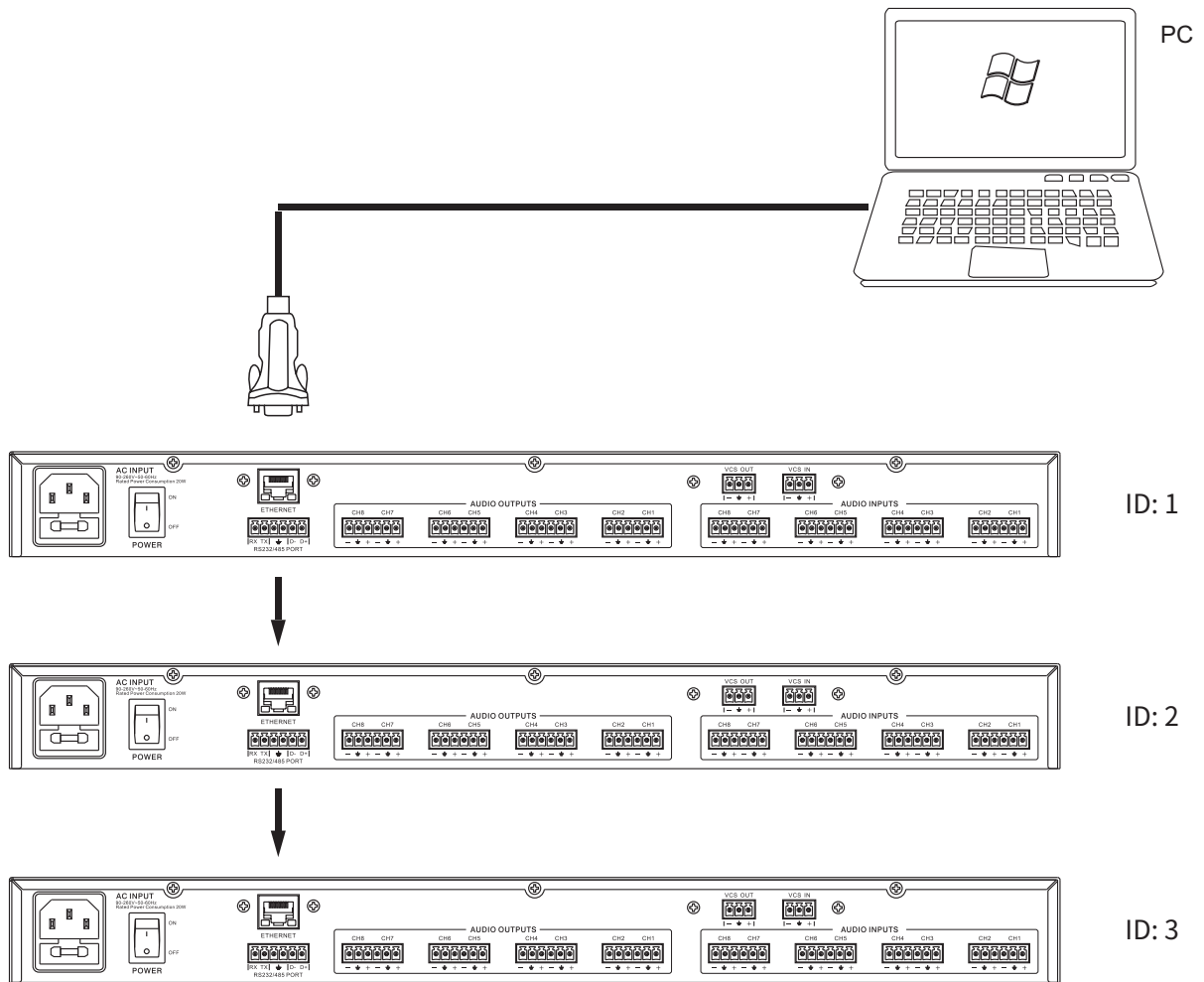

EKX-808 Digital Matrix Processor

4. AEC echo cancellation function operating instructions

AEC echo cancellation system connection diagram

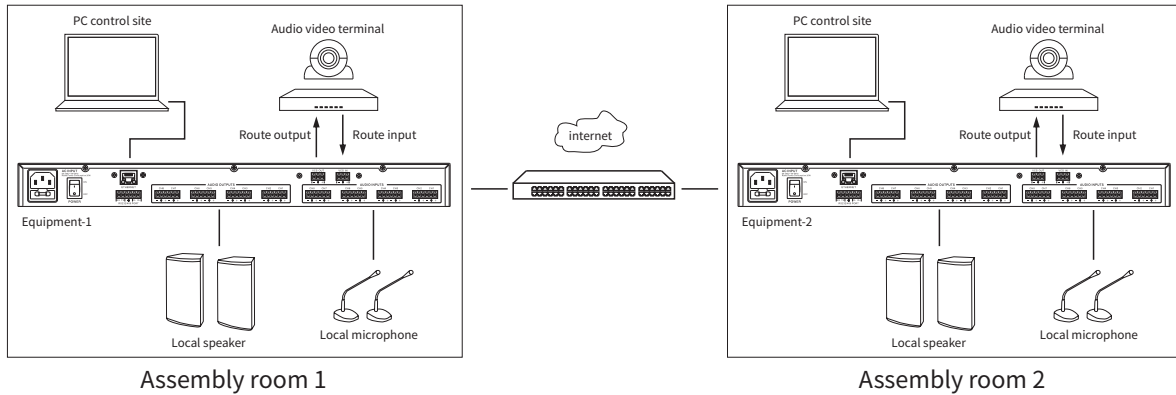

a). Firstly, turn on the gain and phantom power of the input channel microphone.

b). Then choose AUX channel route to the output channel in the Matrix interface. Since AEC function is in AUX channel, AEC can be arbitrarily routed to the output channel (be careful not to direct the input channel to the output channel without AUX).

c). Finally enter AUX interface, choose to mixed with AUX channel input to the MIC channel at first, then open AEC switch ON, click the set key can enter the AEC echo cancellation after volume control interface, under normal circumstances without the echo can be eliminated, if echo cancellation effect is not ideal, can fine-tune VCS IN and the volume of the AEC OUT to match the level (note that MIC IN level also want as far into the volume of VCS IN fairly). NR is noise reduction function. If there is background noise (such as fan, air conditioner, etc.), it can be turned on and used. However, it should be noted that NR has a certain delay in noise reduction and the timbre of the local output is the same as that of the remote output.

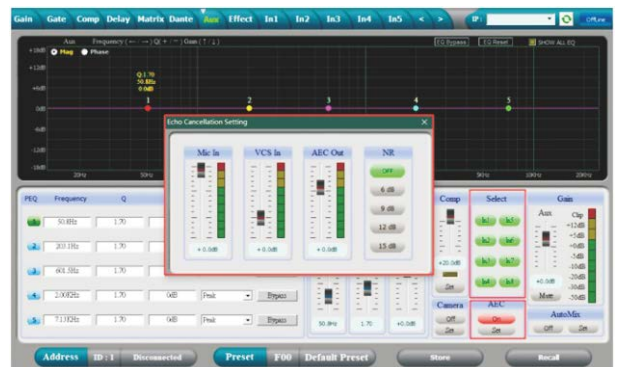

EKX-808 Digital Matrix Processor

232 communication protocol control code

1. Control Package Format

	0	1	2	3	4	5	6	7	8
	DLE	STX	Device Address	CMD	Data1	Data2	Date3	STX	DLE
Packet	0x7B	0x7D	1~254	0x40~0x5C	0x??	0x??	0x??	0x7D	0x7B

2. Command Detail

(1) Load Preset Matrix (0x40)

	0	1	2	3	4	5	6	7	8
	DLE	STX	Device Address	CMD	Factory/User	Preset	0x00	STX	DLE
Packet	0x7B	0x7D	1~254	0x40	F: 0, U: 1	0~12	0	0x7D	0x7B

Example (Load Preset Matrix U02) : 7B7D01400101007D7B

(2) Gain Control (0x41)

	0	1	2	3	4	5	6	7	8
	DLE	STX	Device Address	CMD	In/Out	Channel	+/-	STX	DLE
Packet	0x7B	0x7D	1~254	0x41	In:0 Out:1	00~15	+: 0, -:1	0x7D	0x7B

Example (In1 Gain +) : 7B7D01410000007D7B

(3) Mute Control (0x42)

	0	1	2	3	4	5	6	7	8
	DLE	STX	Device Address	CMD	In/Out	Channel	No/Yes	STX	DLE
Packet	0x7B	0x7D	1~254	0x42	In:0 Out:1	00~15	No:0 Yes:1	0x7D	0x7B

Example (Out1 Un Mute) : 7B7D01420100007D7B

(4) Load Preset Control (0x43)

	0	1	2	3	4	5	6	7	8
	DLE	STX	Device Address	CMD	Factory/User	Preset	0x00	STX	DLE
Packet	0x7B	0x7D	1~254	0x43	F: 0, U: 1	0~12	0	0x7D	0x7B

Example (Recall user's preset U01) : 7B7D01430100007D7B

EKX-808 Digital Matrix Processor

(5) Input Volume Control (0x44)

	0	1	2	3	4	5	6	7	8
	DLE	STX	Device Address	CMD	Channel	HI-VOL	LO-VOL	STX	DLE
Packet	0x7B	0x7D	1~254	0x44	00~15	0x??	0x??	0x7D	0x7B

Example (Set In1 Volume +0.0dB) : 7B7D01440001187D7B

(6) Output Volume Control (0x45)

	0	1	2	3	4	5	6	7	8
	DLE	STX	Device Address	CMD	Channel	HI-VOL	LO-VOL	STX	DLE
Packet	0x7B	0x7D	1~254	0x45	00~15	0x??	0x??	0x7D	0x7B

Example (Set Out2 Volume -3.0dB): 7B7D01450100FA7D7B

(7) Sub Volume Control (0x46)

	0	1	2	3	4	5	6	7	8
	DLE	STX	Device Address	CMD	In/Out	Gain	0x00	STX	DLE
Packet	0x7B	0x7D	1~254	0x46	In:0 Out:1	0~100	0	0x7D	0x7B

Example (Sub Input Gain 90%): 7B7D0146005A007D7B

(8) Sub Gain Control (0x47)

	0	1	2	3	4	5	6	7	8
	DLE	STX	Device Address	CMD	In/Out	+/-	0x00	STX	DLE
Packet	0x7B	0x7D	1~254	0x47	In:0 Out:1	+: 0, -: 1	0	0x7D	0x7B

Example (Sub Input Gain+): 7B7D01470000007D7B

(9) Get Now Gain (0x48)

	0	1	2	3	4	5	6	7	8
	DLE	STX	Device Address	CMD	In/Out	Channel	0x00	STX	DLE
Packet	0x7B	0x7D	1~254	0x48	In:0 Out:1	00~15	0	0x7D	0x7B

MCU Return: 1st Byte: In/Out, 2nd Byte = Channel, 3rd Byte: 0-80(-60~-20): 0.5dB/Step, 80-280(-20~0): 0.1dB/Step, 280-400(0~+12): 0.1dB/Step

Example (Read In1 volume parameter): 7B7D01480000007D7B

EKX-808 Digital Matrix Processor

(10) Get Now Mute (0x49)

	0	1	2	3	4	5	6	7	8
	DLE	STX	Device Address	CMD	In/Out	Channel	0x00	STX	DLE
Packet	0x7B	0x7D	1~254	0x49	In:0, Out:1	00~15	0	0x7D	0x7B

MCU Return: 1st Byte: In/Out, 2nd Byte = Channel, 3rd Byte: 0x00 or 0x01 = Un-Mute or Mute

Example (Read In1 mute parameter): 7B7D01490000007D7B

(11) Get Now Preset (0x4A)

	0	1	2	3	4	5	6	7	8
	DLE	STX	Device Address	CMD	0x30	0x00	0x00	STX	DLE
Packet	0x7B	0x7D	1~254	0x4A	0	0	0	0x7D	0x7B

MCU Return: 0x00 ~ 0x0C = 0: F00, 1~12: U01~U12

Example (Read preset parameter): 7B7D014A0000007D7B

(12) Get Now Sub (0x4B)

	0	1	2	3	4	5	6	7	8
	DLE	STX	Device Address	CMD	In/Out	0x00	0x00	STX	DLE
Packet	0x7B	0x7D	1~254	0x4B	In:0 Out:1	0	0	0x7D	0x7B

MCU Return: 1st Byte: 0 ~ 100%, 2nd Byte = 0x00 or 0x01 = Un-Mute or Mute

Example (Read Sub Input parameter): 7B7D014B0000007D7B

(13) Sub Mute Control (0x4C)

	0	1	2	3	4	5	6	7	8
	DLE	STX	Device Address	CMD	In/Out	No/Yes	0x00	STX	DLE
Packet	0x7B	0x7D	1~254	0x4C	In:0 Out:1	No:0, Yes:1	0	0x7D	0x7B

Example (Sub Output Mute) : 7B7D014C0101007D7B

EKX-808 Digital Matrix Processor

(14) Get Now Level (0x4D)

	0	1	2	3	4	5	6	7	8
	DLE	STX	Device Address	CMD	In/Out	Channel	0x00	STX	DLE
Packet	0x7B	0x7D	1~254	0x4D	In: 0, Out: 1 Aux: 2	00~15	0	0x7D	0x7B

MCU Return: 1st Byte: In/Out, 2nd Byte = Channel, 3rd Byte: -128 ~ -1, 0 ~ +127dB = 0x80 ~ 0xFF, 0x00 ~ 0x7F

Example (Read In1 level): 7B7D014D0000007D7B

Example (Read Out1 level): 7B7D014D0100007D7B

Example (Read Aux level): 7B7D014D0200007D7B

(15) Matrix Control (0x4E)

	0	1	2	3	4	5	6	7	8
	DLE	STX	Device Address	CMD	Channel	In	On/Off	STX	DLE
Packet	0x7B	0x7D	1~254	0x4E	00~15	00~15	On: 1 Off: 0	0x7D	0x7B

Example (Out4 Matrix In2 On): 7B7D014E0301017D7B

(16) Get Matrix (0x4F)

	0	1	2	3	4	5	6	7	8
	DLE	STX	Device Address	CMD	Channel	In	0x00	STX	DLE
Packet	0x7B	0x7D	1~254	0x4F	00~15	00~15	0	0x7D	0x7B

MCU Return: 0x00 or 0x01 = Off or On

Example (Read Out3 Matrix In3 Parameter): 7B7D014F0202007D7B

(17) Aux Gain Control (0x51)

	0	1	2	3	4	5	6	7	8
	DLE	STX	Device Address	CMD	Aux	0x00	+/-	STX	DLE
Packet	0x7B	0x7D	1~254	0x51	0x02	0x00	+:0,-:1	0x7D	0x7B

Example (Aux Gain): 7B7D01510200007D7B

(18) Aux Mute Control (0x52)

	0	1	2	3	4	5	6	7	8
	DLE	STX	Device Address	CMD	Aux	0x00	No/Yes	STX	DLE
Packet	0x7B	0x7D	1~254	0x52	0x02	0x00	No:0,Yes:1	0x7D	0x7B

Example (Aux Mute): 7B7D01520200017D7B

EKX-808 Digital Matrix Processor

(19) Aux Volume Control (0x53)

	0	1	2	3	4	5	6	7	8
	DLE	STX	Device Address	CMD	Aux	HI-VOL	HI-VOL	STX	DLE
Packet	0x7B	0x7D	1~254	0x53	0x02	0x??	0x??	0x7D	0x7B

Example (Aux Volume +0.0dB): 7B7D01530201187D7B

(20) Volume Step Control (0x54)

	0	1	2	3	4	5	6	7	8
	DLE	STX	Device Address	CMD	In/Out	Channel	+/-	STX	DLE
Packet	0x7B	0x7D	1~254	0x54	In:0, Out:1	00~15	+:0, -:1	0x7D	0x7B

-60dB~-20dB: 2dB/Step, -20dB~+12dB: 1dB/Step

Example (Volume): 7B7D01540000007D7B

(21) Aux On Off Control (0x55)

	0	1	2	3	4	5	6	7	8
	DLE	STX	Device Address	CMD	0x02	Select	On/Off	STX	DLE
Packet	0x7B	0x7D	1~254	0x55	0x02	0:effect 1: Camera 2: AutoMix 3: AEC 4: NR	0:Off 1:Yes	0x7D	0x7B

Example (Effect On): 7B7D01550200017D7B

Example (Camera On): 7B7D01550201017D7B

Example (AutoMix On): 7B7D01550202017D7B

Example (ECHO On): 7B7D01550203017D7B

Example (Noise Redustion On): 7B7D01550204017D7B

(22) Aux Ch Select Control (0x56)

	0	1	2	3	4	5	6	7	8
	DLE	STX	Device Address	CMD	Select	Ch 16~9	Ch 8~1	STX	DLE
Packet	0x7B	0x7D	1~254	0x56	0: AUX 1: Camera 2: Auto Mix	Bit0 ~Bit7: 0:No 1:Yes	Bit0 ~Bit7: 0:No 1:Yes	0x7D	0x7B

Example (Aux In1&In3): 7B7D01560000057D7B

Example (Aux Camera In2&In4): 7B7D015601000A7D7B

Example (Aux Auto Mix In5&In6): 7B7D01560200307D7B

EKX-808 Digital Matrix Processor

(23) FBQ Control (0x57)

	0	1	2	3	4	5	6	7	8
	DLE	STX	Device Address	CMD	0X00	Channel	FBQ	STX	DLE
Packet	0x7B	0x7D	1~254	0x57	0X00	00~15	0:OFF, 1~4: Level	0x7D	0x7B

Example (In3 FBQ Level3): 7B7D01570002037D7B

(24) Get Aux Now Gain (0x58)

	0	1	2	3	4	5	6	7	8
	DLE	STX	Device Address	CMD	Aux	0x00	0x00	STX	DLE
Packet	0x7B	0x7D	1~254	0x58	0x02	0x00	0x00	0x7D	0x7B

MCU Return: 1st Byte: Aux/Effect, 2nd and 3rd Byte: 0-80(-60~-20): 0.5dB/Step, 80-280(-20~0): 0.1dB/Step, 280-400 (0~+12): 0.1dB/Step

Example (Get Aux Gain): 7B7D01580200007D7B

(25) Get Aux Now Mute (0x59)

	0	1	2	3	4	5	6	7	8
	DLE	STX	Device Address	CMD	Aux	0x00	0x00	STX	DLE
Packet	0x7B	0x7D	1~254	0x59	0x02	0x00	0x00	0x7D	0x7B

MCU Return: 1st Byte: Aux/Effect, 2nd Byte: 0x00 or 0x01 = Un-Mute or Mute

Example (Get Aux Mute): 7B7D01590200007D7B

(26) Get Aux On Off (0x5B)

	0	1	2	3	4	5	6	7	8
	DLE	STX	Device Address	CMD	0x02	Select	0x00	STX	DLE
Packet	0x7B	0x7D	1~254	0x5B	0x02	0:effect 1: Camera 2: AutoMix 3: AEC 4: NR	0x00	0x7D	0x7B

MCU Return: 1st Byte: Select, 2nd Byte: 0x00 or 0x01 = On or Off

Example (Effect Switch Parameter): 7B7D015B0200007D7B

Example (Get Aux Camera Switch Parameter): 7B7D015B0201007D7B

Example (Get Aux Auto Mixing Parameter): 7B7D015B0202007D7B

Example (Get Aux ECHO Parameter): 7B7D015B0203007D7B

Example (Get Aux Noise Reduction Parameter): 7B7D015B0204007D7B

EKX-808 Digital Matrix Processor

(27) Get Aux Now Ch Select (0x5C)

	0	1	2	3	4	5	6	7	8
	DLE	STX	Device Address	CMD	0x02	Select	0x00	STX	DLE
Packet	0x7B	0x7D	1~254	0x5C	0x02	0:AUX 1:Camera 2:AutoMix	0x00	0x7D	0x7B

MCU Return: 1st Byte: Select, 2nd Byte: Matrix

Example (Get Aux Ch Select): 7B7D015C0200007D7B

(28) Get Now FBQ (0x5E)

	0	1	2	3	4	5	6	7	8
	DLE	STX	Device Address	CMD	0x00	Channel	FBQ	STX	DLE
Packet	0x7B	0x7D	1~254	0x5E	0x00	0~15	0: off 1~4: Level	0x7D	0x7B

MCU Return: 1st Byte: Channel, 2nd Byte = Level

Example (Get In5 FBQ): 7B7D015E0004007D7B

(29) Get Full Matrix (0x61)

	0	1	2	3	4	5	6	7	8
	DLE	STX	Device Address	CMD	0x00	0x00	0x00	STX	DLE
Packet	0x7B	0x7D	1~254	0x61	0x00	0x00	0x00	0x7D	0x7B

MCU Return: 1st Byte: Channel, 2nd Byte = Matrix, total 5 x 32 = 160 Bytes

Example (Get Full Matrix code Parameter): 7B7D01610000007D7B

(30) Get Group Parameter (0x63)

	0	1	2	3	4	5	6	7	8
	DLE	STX	Device Address	CMD	Group In1 Group Out4	0x00	0x00	STX	DLE
Packet	0x7B	0x7D	1~254	0x63	0~7	0x00	0x00	0x7D	0x7B

MCU Return: 1st Byte: Channel, 2nd Byte: Volume, 3rd Byte: Mute, 4th Byte = Matrix, total 2 Bytes

Example (Get Group Parameter): 7B7D01630000007D7B

EKX-808 Digital Matrix Processor

(31) Group Volume Control (0x66)

	0	1	2	3	4	5	6	7	8
	DLE	STX	Device Address	CMD	Group In1 Group Out4	Gain	0x00	STX	DLE
Packet	0x7B	0x7D	1~254	0x66	0~7	0~100	0	0x7D	0x7B

Example (Input Group 2 Volume 90%): 7B7D0166015A007D7B

(32) Group Gain Control (0x67)

	0	1	2	3	4	5	6	7	8
	DLE	STX	Device Address	CMD	Group In1 Group Out4	+/-	0x00	STX	DLE
Packet	0x7B	0x7D	1~254	0x67	0~7	+ : 0, - : 1	0	0x7D	0x7B

Example (Promote Output Group 3 Increasing Marshalling): 7B7D01670600007D7B

(33) Group Mute Control (0x68)

	0	1	2	3	4	5	6	7	8
	DLE	STX	Device Address	CMD	Group In1 Group Out4	No/Yes	0x00	STX	DLE
Packet	0x7B	0x7D	1~254	0x68	0~7	No: 0, Yes: 1	0	0x7D	0x7B

Example (Output Group 4 Mute): 7B7D01680701007D7B

(34) Group Matrix Control (0x69)

	0	1	2	3	4	5	6	7	8
	DLE	STX	Device Address	CMD	Group In1 Group Out4	Ch 16~9	Ch 8~1	STX	DLE
Packet	0x7B	0x7D	1~254	0x69	0~7	Bit0~Bit7: 0:No 1:Yes	Bit0~Bit7: 0:No 1:Yes	0x7D	0x7B

Example (Input Group 3 In 11& In13): 7B7D01690214007D7B

Mcu Will Return The “OK” For Correct Control Command: 0x4F 0x4B

Communicate Paramete	Baud Rate	115200	Stop Bit	1
	Data Bit	8	Step	>=200ms
	Parity	None	ID	Default 1

EKX-808 Digital Matrix Processor

Safety Instruction

PLEASE READ THESE SAFETY MATTERS CAREFULLY BEFORE USE:

• This product must make sure connect to the ground correctly. If it has broken down, to avoid any electric shock, the device power cord and plug both equipped safety ground connection. The power cord should according to the requirement to install and ground connection.

Warning: Incorrect ground connection might be caused electric shock happen!

If you have any inquiry about the ground connection, please let qualified people checking it or fix it, do not change it by yourself. If the power plug is unsuitable, you can entrust electrician or professional staff to install the suitable power plug.

- To avoid the risk of injury, please close supervision when using the product near child.
- Please do not use the device at wet place, such as: near bathtub, washbasin, kitchen sink, wet basement or near swimming pool and lake.
- It should not be placed near the device which filled with liquids such as the vase.
- This product should install at draughty place or dry environment.
- The power source type must be match to the operation instruction or the volts type which on the product.
- The product must keep away from heat source, such as: electric heater, electric blanket or other heat source products.
- The product equipped one power cord that complied with safety certification. If you can't insert the power cord into the plug, please contact electrician or professional staff to change the old plug. Attention that should not break the power plug safety device.
- If the product not for operation for a long time. Please pull out the power cord from power plug. Don't drag the power cord
- This product use coupler as a make and break device, should be maintained convenient operation
- Please don't operate the product when following things opened, should call qualified people checking it or fix it:
A.Power cord damaged.
B.Objects or liquid get into the product. C.The product is sopping with rain.
D.The product can not operate correctly or show obvious unusual. E.The product dropped down, damaged.
- Any inquiries about the product which not mentioned in the user manuals, please contact the eligible electrician or professional staff to repair.

- Only apply to security use which area below altitude of 2000m.



- Only apply to security use which condition except tropical climate.



Pay attention to the dangerous voltage of the insulation within the products. It may be considerable damage to human body.



Important Notices and Operation Instructions.

CAUTION



To avoid the electric shock should not open it



Caution: to avoid electric shock, please don't remove the bottom. If it has any problems should not repair it by yourself, please entrust professional staff to repair it.

WARNING:

Please do not let the heavy extrusion or stamp on the power cord, avoid by all pull or distort the power cord. To avoid the risk of fire or electric shock, please do not use unqualified power cord.

注意事项：

- 本单为保修凭证，请用户妥善保管，如有遗失，恕不保修或退换。
- 保修期限制：购买之日起十二个月内。
- 除了不可抗力事件损坏外，由本公司负责，免费维修。
- 如属保管不善或使用不当造成的损坏，维修点将酌情收费。
- 擅自拆卸维修者，不予保修。
- 以上保修条款仅限于中国市场适用（不含港澳台地区）。

产品服务保证书

姓名：_____ 电话：_____ 地址：_____

商品：_____ 型号：_____ 购买日期：_____ 年 _____ 月 _____ 日

维修记录栏（由维修员填写）	维修员签名	日期

◆ 广东得胜电子有限公司 ◆ 电话：400-6828-333 ◆ 地址：广东省惠州市博罗县龙溪街道富康一路2号



扫一扫，了解更多产品

Scan for more

product information

广东省电声工程技术研究开发中心 广东得胜电子有限公司制造

地址：广东省惠州市博罗县龙溪街道富康一路2号

服务热线：400 6828 333 传真：0752-6383950

邮箱：xs@takstar.com

网址：www.takstar.com

Guangdong Takstar Electronic Co., Ltd.

Address: No. 2 Fu Kang Yi Rd., Longxi Boluo

Huizhou, Guangdong 516121 China

Tel: 86 752 6383644 Fax: 86 752 6383952

Email: sales@takstar.com

Website: www.takstar.com